



Leadshine

Hardware Installation Manual

MX3660

3-Axis Stepper Drive with Breakout Board & I/O's



Version 1.1

12 / 2013

<http://www.Leadshine.com>

<http://www.Leadshineusa.com>

©2013 Leadshine Technology Co., Ltd.

Notice

Read this manual carefully and the MX3660 datasheet before any assembling and using. Incorrect handling of products in this manual can result in injury and damage to persons and machinery. Strictly adhere to the technical information regarding installation requirements.

This manual is not for use or disclosure outside of Leadshine except under permission. All rights are reserved. No part of this manual shall be reproduced, stored in retrieval form, or transmitted by any means, electronic, mechanical, photocopying, recording, or otherwise without approval from Leadshine. While every precaution has been taken in the preparation of the book, Leadshine assumes no responsibility for errors or omissions. Neither is any liability assumed for damages resulting from the use of the information contained herein.

This document is proprietary information of Leadshine that is furnished for customer use ONLY. Information in this document is subject to change without notice and does not represent a commitment on the part of Leadshine. Therefore, information contained in this manual may be updated from time-to-time due to product improvements, etc., and may not conform in every respect to former issues.

Record of Revisions

Revision	Date	Description of Release
<i>1.0</i>	<i>11/2013</i>	<i>Initial Release</i>
<i>1.1</i>	<i>12/2013</i>	<i>Updates for connection diagram and digital output description</i>

Contents

1. INTRODUCTION	4
2. FEATURES	4
3. APPLICATIONS	4
4. BLOCK DIAGRAM	5
5. DIMENSIONS	6
6. GET STARTED	6
7. CONNECTING A POWER SUPPLY	7
8. CONNECTING STEPPER MOTORS	7
8.1. CONNECTING A 4-LEAD STEPPER MOTOR	7
8.2. CONNECTING A 6-LEAD STEPPER MOTOR	8
8.2.1. CONNECTING A 6-LEAD STEPPER MOTOR IN SERIES CONNECTION	8
8.2.2. CONNECTING A 6-LEAD STEPPER MOTOR IN SERIES CONNECTION	8
8.3. CONNECTING A 8-LEAD STEPPER MOTOR	9
8.3.1. CONNECTING A 8-LEAD STEPPER MOTOR IN SERIES CONNECTION	9
8.3.2. CONNECTING A 8-LEAD STEPPER MOTOR IN PARALLEL CONNECTION	9
9. CONNECTING AN E-STOP SWITCH OR SHORTING THE CONNECTION	10
10. ENABLING / DISABLING CHARGE PUMP	11
11. SETTING THE "SMOOTHER" SWITCH	11
12. CONFIGURING OUTPUT CURRENT AND MICRO STEP	12
12.1. CONFIGURING THE OUTPUT CURRENT	12
12.2. CONFIGURING THE OUTPUT CURRENT	12
13. CONNECTING THE DB25 CONNECTOR	13
13.1. CONNECTING THE DB25 STEP & DIRECTION PINS	13
13.2. CONNECTING THE DB25 FAULT OUTPUT PIN	14
13.3. CONNECTING THE DB25 CHARGE PUMP PIN	14
13.4. CONNECTING THE PWM PIN	14
14. OPTIONAL CONNECTIONS FOR INPUTS/OUTPUTS	15
14.1. CONNECTING THE DIGITAL INPUTS	15
14.2. CONNECTING THE DIGITAL OUTPUTS	15
14.3. CONNECTING THE ANALOG OUTPUT	15
APPENDIX A: MX3660 CONNECTION DIAGRAM	16
APPENDIX B: DB25 CONNECTOR PINOUT	17
APPENDIX C: DIGITAL INPUTS	19
APPENDIX D: DIGITAL OUTPUTS	20
APPENDIX E: OPTO-ISOLATED ANALOG OUTPUT	20
APPENDIX F: STEPPER DRIVE MODULE REPLACEMENT	21
APPENDIX G: WARRANTY INFORMATION	21
APPENDIX H: TROUBLE SHOOTING	21
CONTACT US	22

1. Introduction

Thank you for choosing the Leadshine MX3660, a high performance 3-axis stepper drive with built-in breakout board and I/O's based on the latest DSP technology. The MX3660 is specially designed for EASY and RAPID control of up to three 2-phase (1.8°) stepper motors in frame sizes NEMA 17, 23, 24, and 34. It operates under 20-60 VDC supply voltage and can output up to 6.0A current (peak of sinusoidal) per axis. The MX3660 takes step & direction control and is easy to implement for OEM applications.



The MX3660 can also be used to power 4-phase (0.9°) stepper motors. But in this case, there will be 400 full steps needed for each revolution. You need to make sure that the settings in your controller (motion controller, PLC, CNC control system...) are properly configured to reflect this requirement.

2. Features

- Power up to 3 stepper motors of NEMA 17, 23, 24, or 34
- Sophisticated stepper motor control based on latest DSP technology
- Built-in breakout board and I/O's
- Step & direction Control
- 200 KHz maximum frequency for each axis
- 20 - 60 VDC supply voltage
- 1.45 - 6.0A output current per axis
- 8 micro step settings: 1, 1/2, 1/4, 1/8, 1/10, 1/16, 1/32, 1/64
- 8 output current settings: 1.45, 2.08, 2.72, 3.37, 4.05, 4.72, 5.35, 6.0 A
- Damping and anti resonance
- Allowing individual output current & micro step configurations for each axis
- Input pulse smoothing to improve performance of movement jittering
- Extra low motor heating & noise
- Extra smooth motor movement
- Simple micro step & output current configuration via DIP switches
- Fault output
- Compact size and easy setup
- 50% automatic idle current reduction

3. Applications

The MX3660 3-axis stepper drive can be easily and rapidly implemented in stepper control systems for applications such as CNC routers / engravers, CNC mills, CNC Cutters, laser cutters / markers / engravers, CNC welders, CNC water jets, X-Y tables, lathes, dispensing machines, medical equipment, scientific instruments...

Its unique design with built-in breakout board and I/O's fits seamlessly in many applications powered by many popular CNC control systems such as Mach3, EMC, WinCNC, etc.

4. Block Diagram

The following diagram shows MX3660 main internal components and how it interfaces with other components in the motion control system of your machine/device.

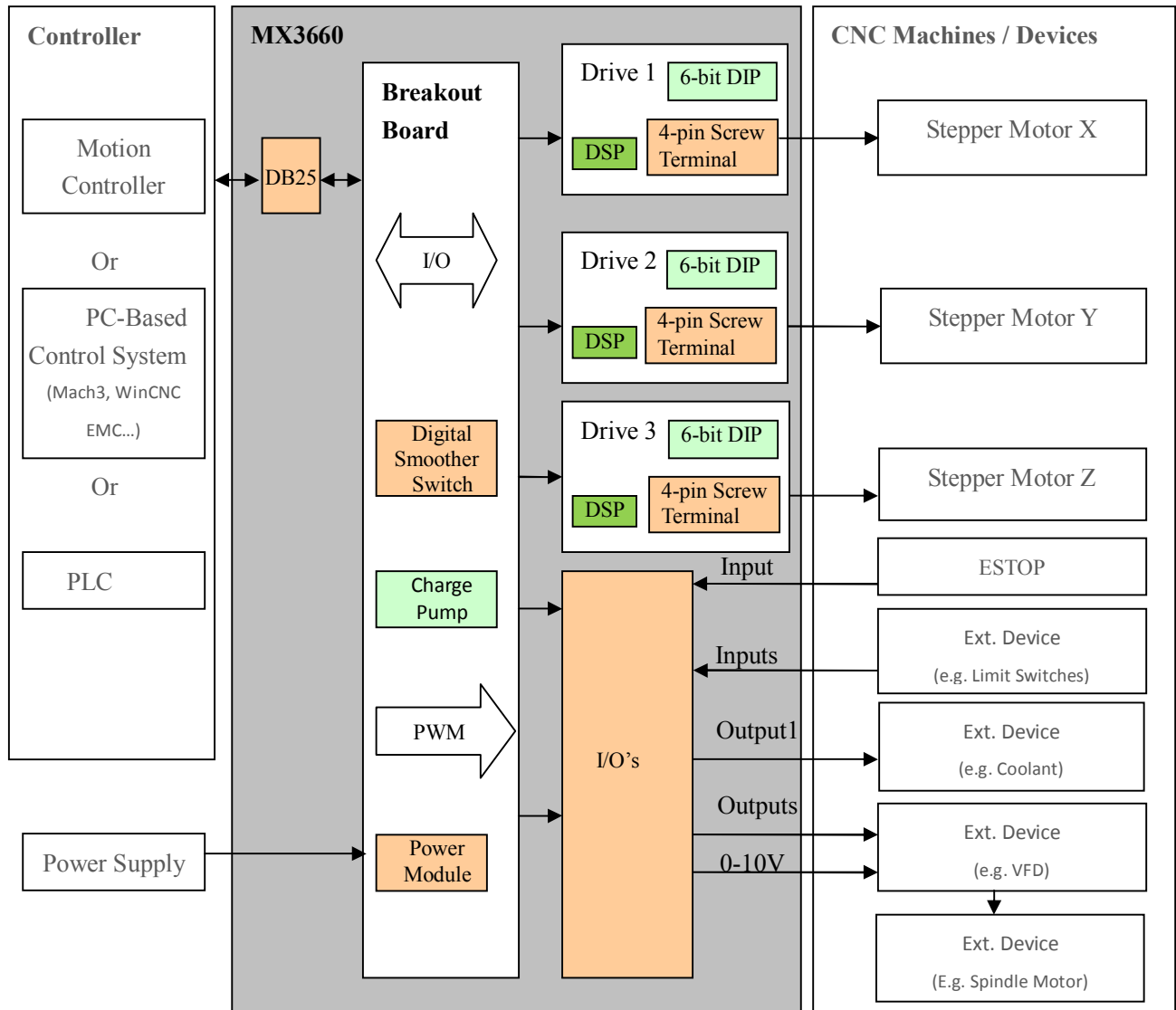

Figure 1 MX3660 Block diagram

5. Dimensions

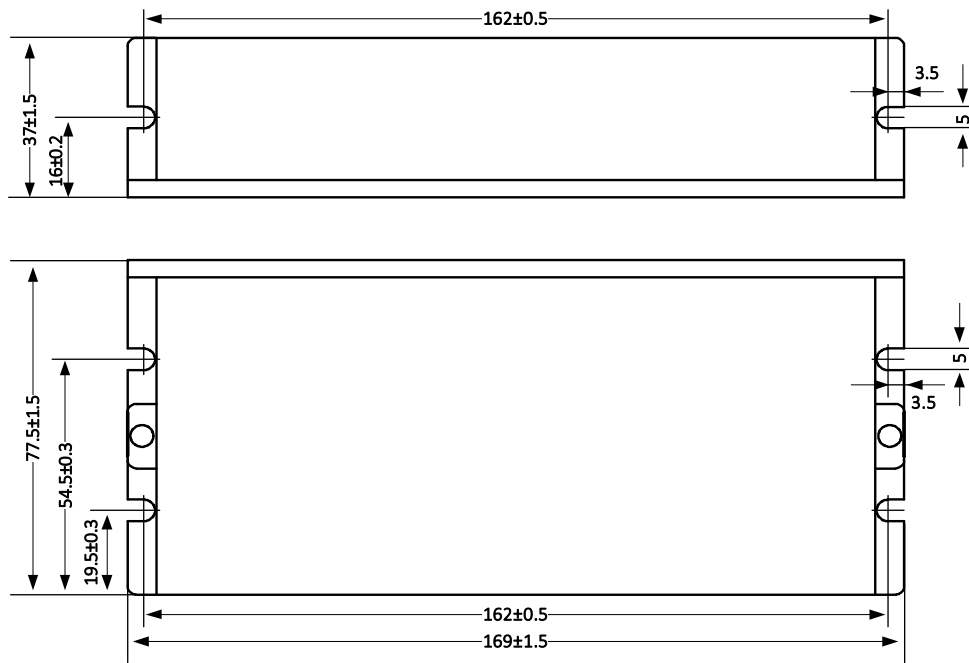

Figure 2 MX3660 dimensions

6. Get Started

Before you start hardware connection, refer to the following MX3660 layout diagram (figure 3) for connector/DIP switch location. Read the MX3660 datasheet for each connector explanation. Then, get the following prepared:

- A 24-54 VDC power supply.
- Up to 3 stepper motors depending on how many axes that MX3660 will power in your application.
- A source of step signals, such as a motion controller, PLC, or a PC-based control system (Mach 3, EMC, etc.).
- A small flat blade screw driver for tightening the screw connectors of the MX3660.
- Whatever optional external devices needed to be controlled through the built-in outputs and inputs.

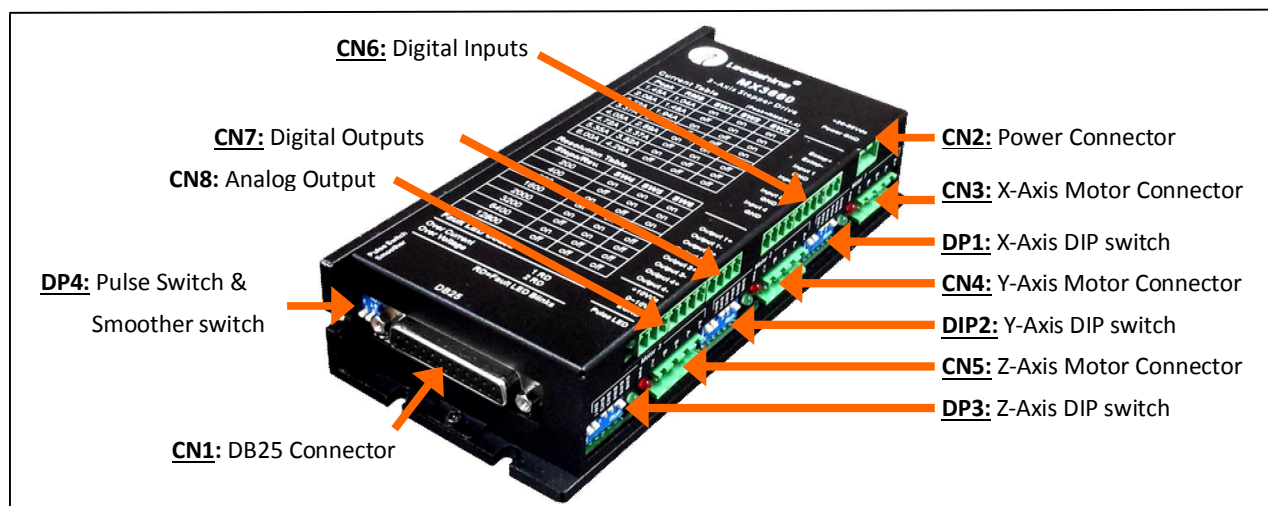

Figure 3 MX3660 layout

7. Connecting a Power Supply

The power supply connector is located at the upper left side of MX3660 (“CN2” in Figure 3). The power supply of the MX3660 can be connected as illustrated in Figure 4. Although MX3660’s working voltage is 20-60 VDC, we suggest the use of a 24-54 VDC power supply to leave room for back EMF voltage charge back during motor deceleration.



Figure 4 Power supply connections



- (1) *Never power on the power supply before finishing all the connections and configurations.*
- (2) *Make sure the two power supply leads, + & -, are correctly connected to the MX3660 power connector. Wrong connection will destroy the MX3660 and void its warranty.*
- (3) *Connecting a power supply with output voltage of 60VDC or up could damage the MX3660, and void its warranty.*

8. Connecting Stepper Motors

There are 3 stepper drive modules for the MX3660 to allow connections of up to three 2-phase stepper motors. Because of the wide output current range from 1.45 to 6.0A for each stepper drive module, the MX3660 can drive various stepper motors in frame sizes NEMA 17, 23, 24, and 34. You can find the 3 stepper drive module location at CN3, CN4, and CN5 on Figure 3. Those stepper motors can be 4-lead, 6-lead, or 8-lead stepper motors.

To get the maximum torque from a stepper motor, the output current required from a stepper drive equals to the motor phase current multiplied by 1.4. Higher output current from a stepper drive module will result the stepper motor torque; but that also increase the motor heating. Therefore, it is recommended to set “just-enough” output current to get the needed torque, and as less motor heating as possible.

8.1. Connecting a 4-Lead Stepper Motor

A 4 lead motor is the easiest to connect, and its speed-torque performance depends on its motor inductance. Refer to the wiring diagram of your stepper motor, and connect its wires to the motor connector to one of the MX3660 stepper drive module. Refer to Figure 5 on next page.

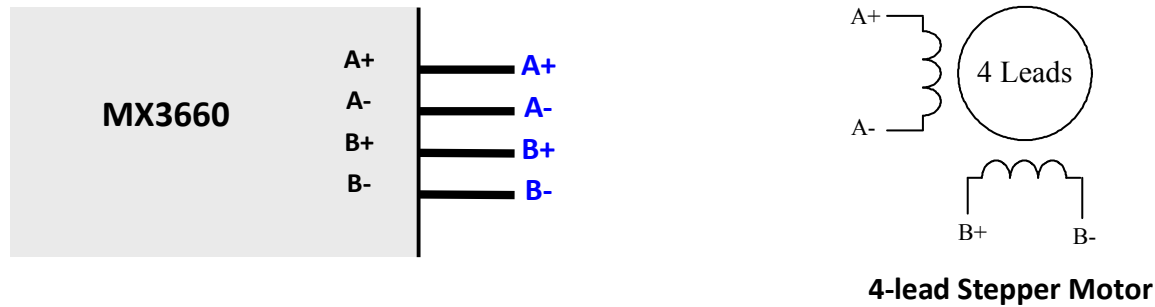

Figure 5 Connecting a 4-lead stepper motor

8.2. Connecting a 6-Lead Stepper Motor

The MX3660 can drive 6-lead stepper motors in either half coil connection or full coil connection. Before the connection, please read the datasheet of your stepper motor.

8.2.1. Connecting a 6-Lead Stepper Motor in series connection

This configuration is also referred to as half chopper. When connecting a 6-lead stepper motor, the half coil configuration uses 50% of the motor phase windings. This results in lower inductance, and hence lower torque output at low-speed movements. Like the parallel connection of an 8 lead motor, this connection is commonly used in applications requiring better high-speed torque performance. Refer to Figure 6 for the connection.

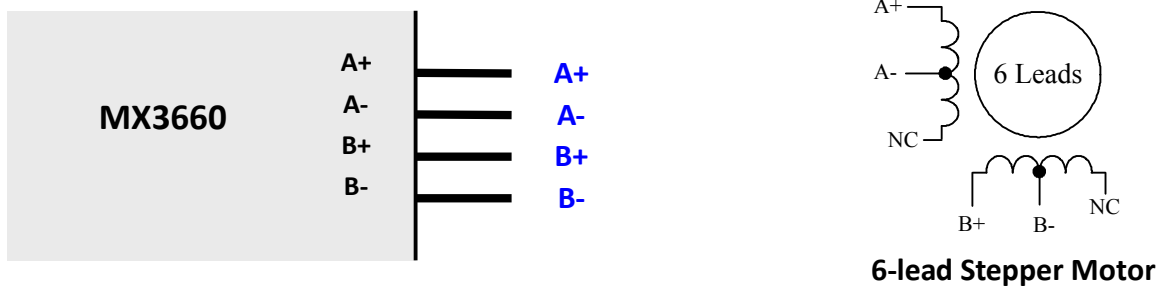

Figure 6 Connecting a 6-lead stepper motor in half-coil

8.2.2. Connecting a 6-Lead Stepper Motor in series connection

This configuration is also referred to as full copper. The full coil connection for a six lead motor is commonly used in applications requiring for higher torque performance at lower-speed movements. Refer to Figure 7 for the connection.

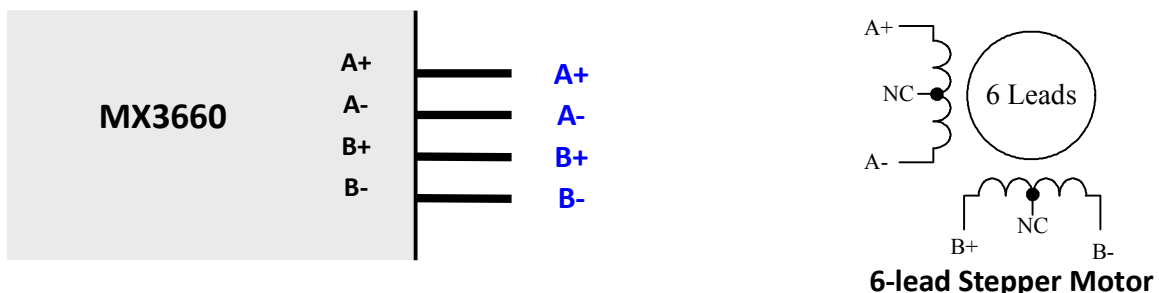

Figure 7 Connecting a 6-lead stepper motor in full coil

8.3. Connecting a 8-Lead Stepper Motor

The MX3660 can drive an 8-lead stepper motor in either series connection or parallel connection. Before the connection, please read the datasheet of your stepper motor.

8.3.1. Connecting a 8-Lead Stepper Motor in series connection

Refer to the wiring diagram of your stepper motor datasheet. Figure 8 illustrates how to connect an 8-lead stepper motor to the MX3660 in series connection.

An 8-lead stepper motor in series connection requires less current, so the motor coils can be charged quicker and achieves peak output torque faster than the same motor connected in parallel connection. This makes series connection preferable for applications that require higher torque at lower speed. But on the other side, because of its higher inductance, 8-lead stepper motor in series connection generates more motor heating and its higher speed torque performance is not good as a parallel connected stepper motor. It is recommended for not setting drive current no more than 70% of its rated current to prevent too much heating for a series connected 8-lead stepper motor, but what current to set is application dependent and at a user's choice.

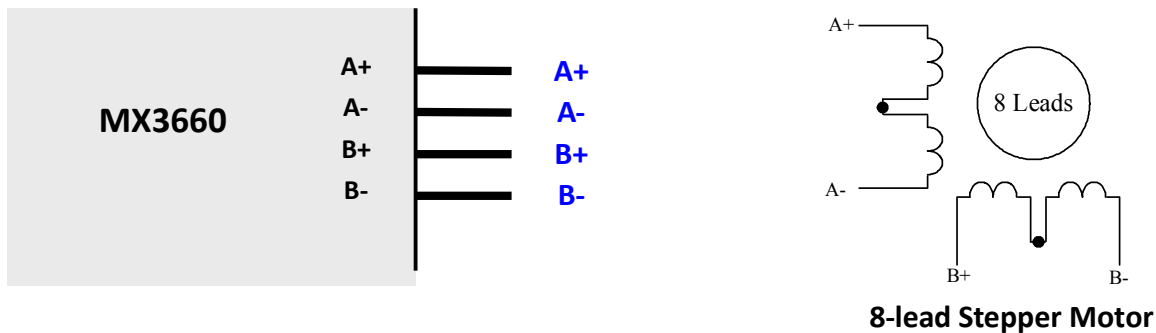

Figure 8 Connecting an 8-lead stepper motor in series connection

8.3.2. Connecting a 8-Lead Stepper Motor in Parallel Connection

Refer to the wiring diagram of your stepper motor datasheet. Figure 9 illustrates how to connect an 8-lead stepper motor to the MX3660 in parallel connection.

Due to the lower inductance for an 8-lead stepper motor in parallel connection, its high speed torque drops slower (*"better high-speed torque"*) than in series connection during higher speed motor rotation. This makes parallel connection preferred for applications runs in high speeds constantly such as CNC Routers. Due to the parallel connected stepper motor will draw more current, thus it also has high requirements for the powering stepper drive. Fortunately, the maximum 6.0A output for each of three stepper drive module will allow MX3660 to drive stepper motors up to NEMA 34 in parallel connection.

Theoretically, to get the maximum torque of a parallel connected 8-lead stepper motor, you should multiply the phase current by 1.4. But it is suggested to set a "just enough" lower value to prevent too much heating from your stepper motor.

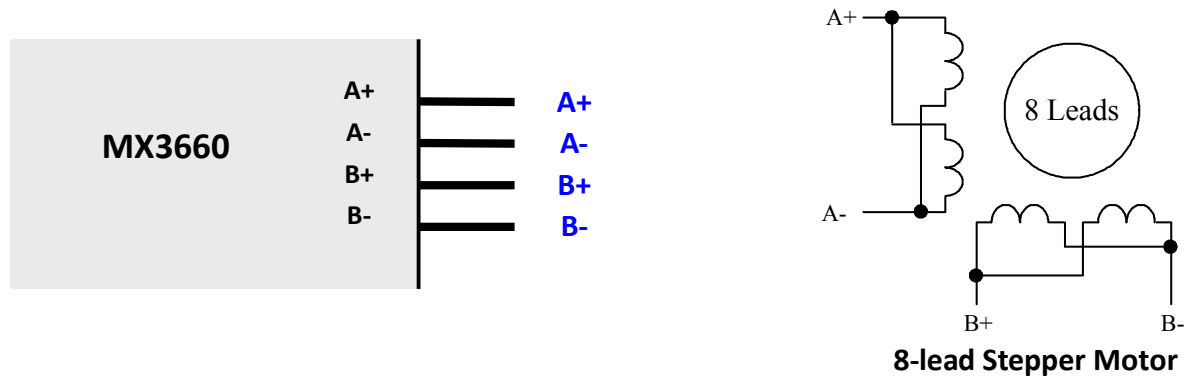

Figure 9 Connecting an 8-lead stepper motor in parallel connection



Never connect or disconnect a stepper motor while the power is on.

9. Connecting an E-Stop Switch or Shorting the Connection

The E-Stop connection is required. The E-Stop connector is located next to the power connector (Figure 3). **By default, the MX3660's activation requires an emergency stop switch connected, or having the two connection pins, "ESTOP+" and "ESTOP-", shorted.**

Refer to Figure 10 for how to connect an E-Stop switch. To short the E-Stop connection, just connect a signal wire between the "ESTOP+" and "ESTOP –" pins.

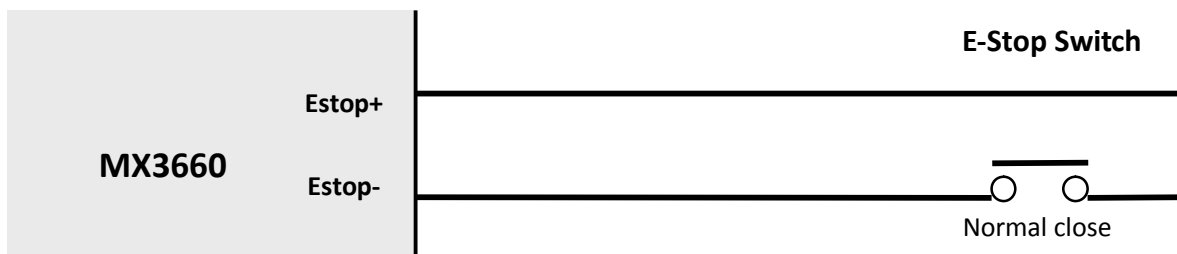

Figure 10 E-stop switch connections



Without the a E-STOP switch connected, or short circuit between Estop+ and Estop- pins, the red LED lights of the 3 stepper drive modules will blink 3 times periodically when MX3660 is powered on

10. Enabling / Disabling Charge Pump

To make MX3660 working properly, setting this switch to the right position is required. The MX3660 is featured with a feature called “Charge Pump”, a watchdog timer to enable/disable MX3660. When the charge pump feature is turned on, the MX3660’s activation will depend on the receiving of 10 KHz signals at pin 16 of the DB 25 connector. When the “Charge Pump” feature is turned off, the MX3660 will be activated without such verification.

By default, the charge pump feature is turned on, with the “Pulse Switch” (next to the DB25 connector) set to the “Off” position (means “Charge Pump” on). To disable this feature and make MX3660 to work with control systems (e.g. PLC, motion controller, etc.) not designed to use the “Charge Pump” feature, set the “Pulse Switch” to “ON” position (meaning “Charge Pump” off).

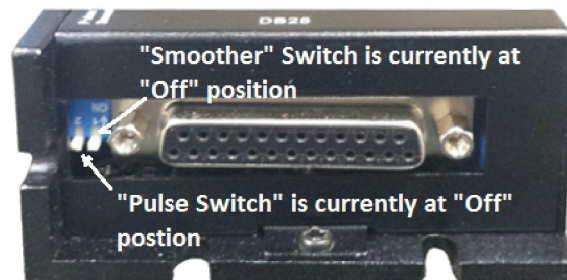

Figure 11 On/Off positions for “Pulse Switch” and “Smoother” Switches



The ON/OFF direction for the “Pulse Switch” is different from the ON/Off direction of the DIP switch in a stepper drive module, which is used to configure the output current and micro step by a stepper drive module. Refer to Figure 11.

11. Setting the “Smoother” Switch

The firmware of each of the three stepper drive modules in the MX3660 adopts a feature called “smoothing” to smooth input step signals. When an input pulse emulated by the connected motion controller or CNC control system are not in linear or equivalent width, called “noise pulse”, it will cause erratic motion and additional motor/drive noise. Turning on the built-in digital smoother will trigger the input pulse train smoothing and could potentially improve motion performance such as less jittering, higher torque, and quicker response. Because of the complexity for different machines/devices, the “Smoother” feature may or may not have obvious effect (but at least no hurt for the bottom line). Turning on this switch or off is totally your choice.

The “Smoother” switch is located next to the DB25 connector. By default, the MX3660 smoother is set to off.



The ON/OFF direction for the “Smoother” switch is different from the ON/OFF direction of the three DIP switches for the 3 stepper drive modules, which is used to configure output current and micro step by a stepper drive module. Refer to Figure 11 for “Smoother” switch direction.

12. Configuring Output Current and Micro Step

The MX3660 allows individual settings of the output current and micro step resolution for each stepper motor, via the 6-pin DIP switches of three stepper drive modules (DP1, DP2, and DP3 on Figure 3).

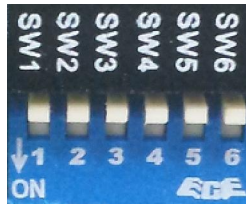

Figure 12 DIP switch for current & micro step configurations

12.1. Configuring Output Current

The output current configuration is required. Use SW1, SW2, and SW3 of the 6-pin DIP switch (Figure 12) of a stepper drive module to configure the output current to the driven stepper motor. Refer to Table 1 for available output current settings.

Peak	RMS	SW1	SW2	SW3
1.45A	1.04A	on	On	On
2.08A	1.48A	off	On	On
2.72A	1.94A	on	Off	On
3.37A	2.41A	off	Off	On
4.05A	2.89A	on	On	Off
4.72A	3.37A	off	On	Off
5.35A	3.82A	on	Off	Off
6.00A	4.29A	off	Off	Off

Table 1 output current settings for a stepper drive module

12.2. Configuring Micro Step Resolution

The micro step resolution configuration is required. Use pin 4, 5, and 6 of the 6-pin DIP switch (Figure 12) of a stepper drive module to configure the micro step resolution for the driven stepper motor. Refer to Table 2 for available micro step resolution settings.

Micro Step	Steps/Rev	SW4	SW5	SW6
Full	200	On	On	On
Half	400	Off	On	On
1 / 4	800	On	Off	On
1 / 8	1600	Off	Off	On
1 / 10	2000	On	On	Off
1 / 16	3200	Off	On	Off
1 / 32	6400	On	Off	Off
1 / 64	12800	Off	Off	Off

Table2 Micro step settings for a stepper drive module

13. Connecting the DB25 Connector

Refer to “**Appendix A**” for detail specification for the MX3660 DB25 connector pin-out. The DB25 connector is used to connect, directly / indirectly (e.g. via a circuit board), to a source of control signals (“controller” hereafter) such as a motion controller, a PLC, an indexer, PC-based control system (e.g. Mach 3, EMC, WinCNC, etc.).

The controller is the “Brain” of the whole motion control system for: (1) sending signals of step, direction, and charge pump, to control the MX3660; (2) sending digital/analog signals for the controls of external devices, which are connected at MX3660 digital output connector; (3) accepting “Fault” output from the MX3660; (4) take input signals sent from the external devices connected at MX 3660 digital input connector.

We will only depict the pin connections for step & direction, fault output, charge pump, and PWM. Refer to **Appendix A** for pin outs for other optional I/O’s

13.1. Connecting the DB25 Step & Direction Pins

The step and direction pin connections are required. Step signals are sent to MX3660 via pin 2, 4, 6 of the DB25 connector. Direction signals are sent to MX3660 via pin 3, 5, 7. Refer to Figure 13.

Step and direction signal voltage should be 3.3-5 VDC and “Active High”. In the controller configuration, the step width should be configured to a value at least 2.5 μ S, and direction setup time needs to be at least 5 μ S. Otherwise, it could cause loss of steps, or no motion at all for the controlled stepper motors.

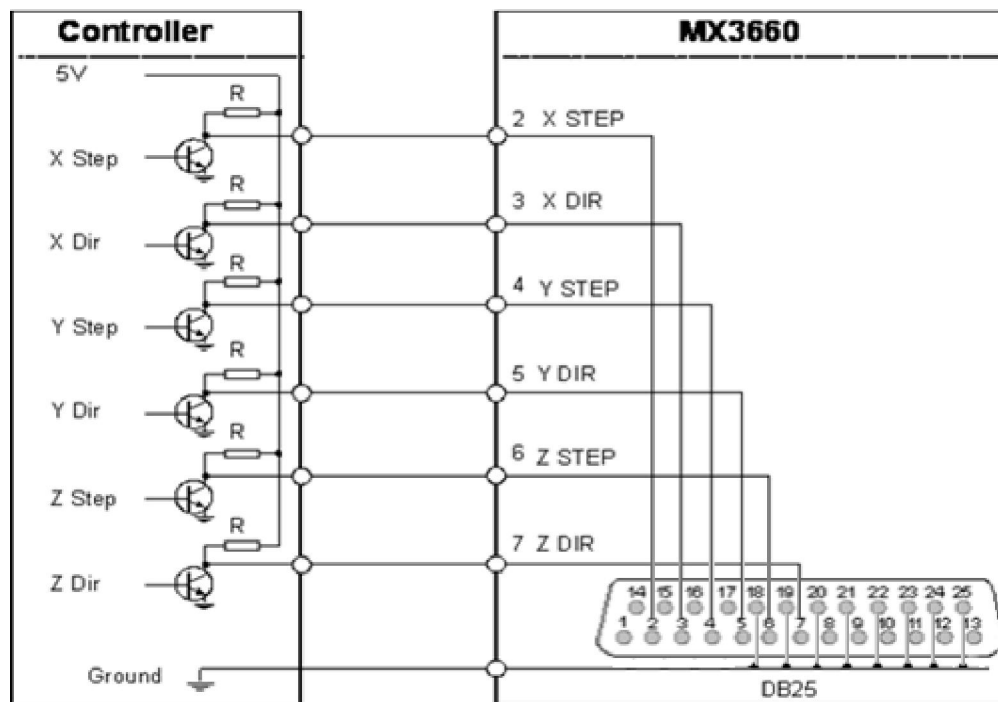

Figure 13 Connecting the step & direction signals of a controller to the MX3660



If step & direction signal voltage is lower than 5 VDC, you may need to increase step width and direction setup time (> 5 μ S) to move your motors, or avoid loss of step.

13.2. Connecting the DB25 Fault Output Pin

The fault pin connection is optional. The MX3660 3-axis stepper drive will send a “Fault” output signal of 5 VDC back to the controller via Pin 15 (Appendix A) of the DB25 connector, in one of the following scenario:

- Any of the 3 stepper drive module is in protection mode including over voltage and over current. Read “Protection” detail in the MX3660 datasheet.
- The connected external E-Stop switch in the digital input is pressed.

With the receiving of a fault received from the MX3660, a controller can be notified an abnormal event has happened. It can then react, such as shutting down the whole control machine/device for machine damage.

13.3. Connecting the DB 25 Charge Pump Pin

The charge pump pin connection is optional. To implement the “charge pump” feature of the MX3660 3-axis stepper drive, turn off the Pulse Switch (page 7) and keep sending 10 KHz signals to Pin 16 of the DB25 connector while the controller works properly. In this scenario, the “PULSE LED” on the MX3660 will be turned on to indicate that everything is fine. When no such signal received, MX3660 will be disabled with the “PULSE LED” light off, to prevent from any further action caused by controller malfunction for connected stepper motors and external devices. Read “Enabling / Disabling Charge Pump” on page 7 for additional information.

Connecting the DB25 PWM Pin

The PWM pin connection is optional. The MX3660 can take PWM signals from the controller, through Pin 14 of the DB25 connector, transform it into an analog signal, and output as analog voltage signal at the “0-10V” pin of the analog output connector (Figure 3). This will allow the control of an external analog device such as a VFD for spindle speed control in a CNC router.

14. Optional Connections for Inputs/Outputs

The MX3660 3-axis stepper drive is equipped with 4 built-in digital inputs, 4 digital outputs, and one 0-10 V analog output. Those connections are totally optional and not required to make the MX3550 work.

14.1. Connecting the Digital Inputs

The digital input connections are optional. The 4 general digital inputs are located at the Digital Input Connector (Figure 3) of the MX3660. They are named as *Input 1*, *Input 2*, *Input 3*, and *Input 4*. They can be used for any purpose such as connecting limit/home switches. Connect one end of your device wire to the “Input X” (X can be 1, 2, 3, or 4) pin, and the other wire to “GND” pin next to the input pin (for one wire device, short it to GRD).

On Figure 14, it shows how to connect a home/limit switch to digital input “Input 1”.

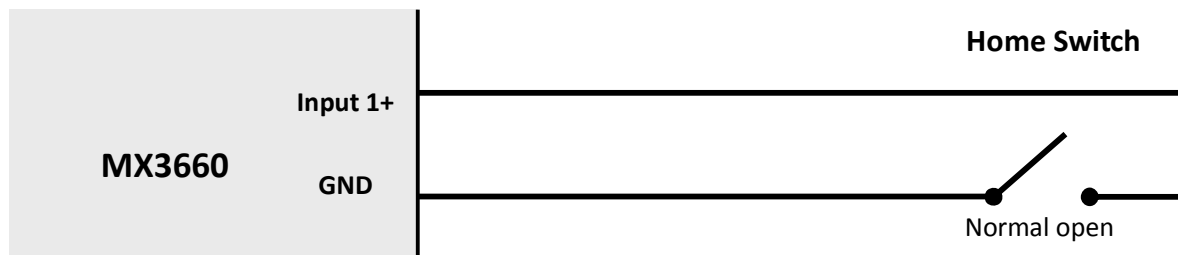

Figure 14 Home / limit switch connections of the MX3660

14.2. Connecting the Digital Outputs

The digital Output Connections are optional. The 4 general digital outputs are located at the Digital Output Connector (Figure 3) of the MX3660, named as *Output 1*, *Output 2*, *Output 3*, and *Output 4*. They can be used for any purpose such as a DC relay for coolant in a CNC router. They are connected to Pin 17, 1, 8, and 9 of the ssDB25 connector respectively. They can be used for other purpose such as a DC relay for coolant in a CNC router. Connect one end of the load to “Output X+” (X can be 1, 2, 3, or 4) pin and the other end to the VDC+ of a 5-24VDC power source. Then, connect the related “Output X-” pin of MX3660 to the power supply VDC-. Those digital outputs are rated at max 70mA. Refer to figure 16 of “MX3660 Connection Diagram”.



When the input voltage of the main power supply is higher than 24 VDC, you can't use it to supply power to the 4 digital outputs, and another power source or 5-24 power supply has to be used.

14.3. Connecting the Analog Output

The analog output connection is optional. The MX3660 3-axis stepper drive also comes with an opto-isolated analog output (Figure 3) to allow control of an external analog device, such as a VFD for spindle control. Supply voltage for the analog device is 5-15 VDC, and the output voltage signal is 0 to (Analog Supply Voltage minus 1.1 VDC).

On Figure 15, it shows how to connect a VFD to the opto-isolated analog output. Connect the VFD 10 VDC power wire to “+10 VDC” pin, “Input” wire to “0-10V”, and GND wire to “GND”, and

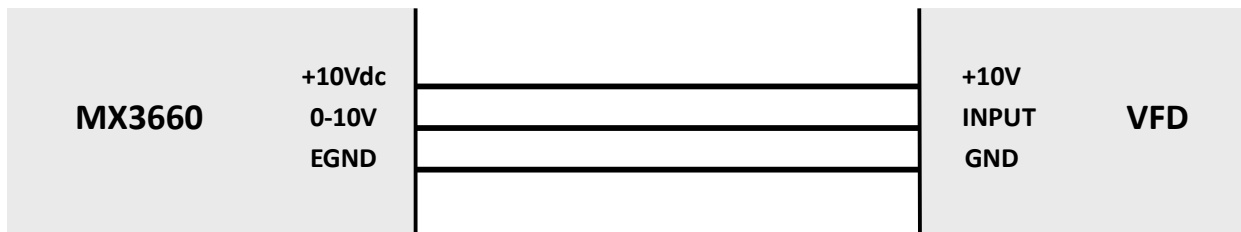

Figure 15 Connecting a VFD to the MX3660

Appendix A: MX3660 Connection Diagram

When implemented properly, the MX3660 can be used to power three 2 phase (1.8°) stepper motors of NEMA 17, 23, 24, and 34. In addition, it can also allow controls of optional external devices via the built-in digital inputs, digital outputs, and the opto-isolated analog output. Figure 6 illustrates the MX3660 connection diagram with 3 stepper motors. External devices through MX3660 I/O connections are optional at a user's choice.

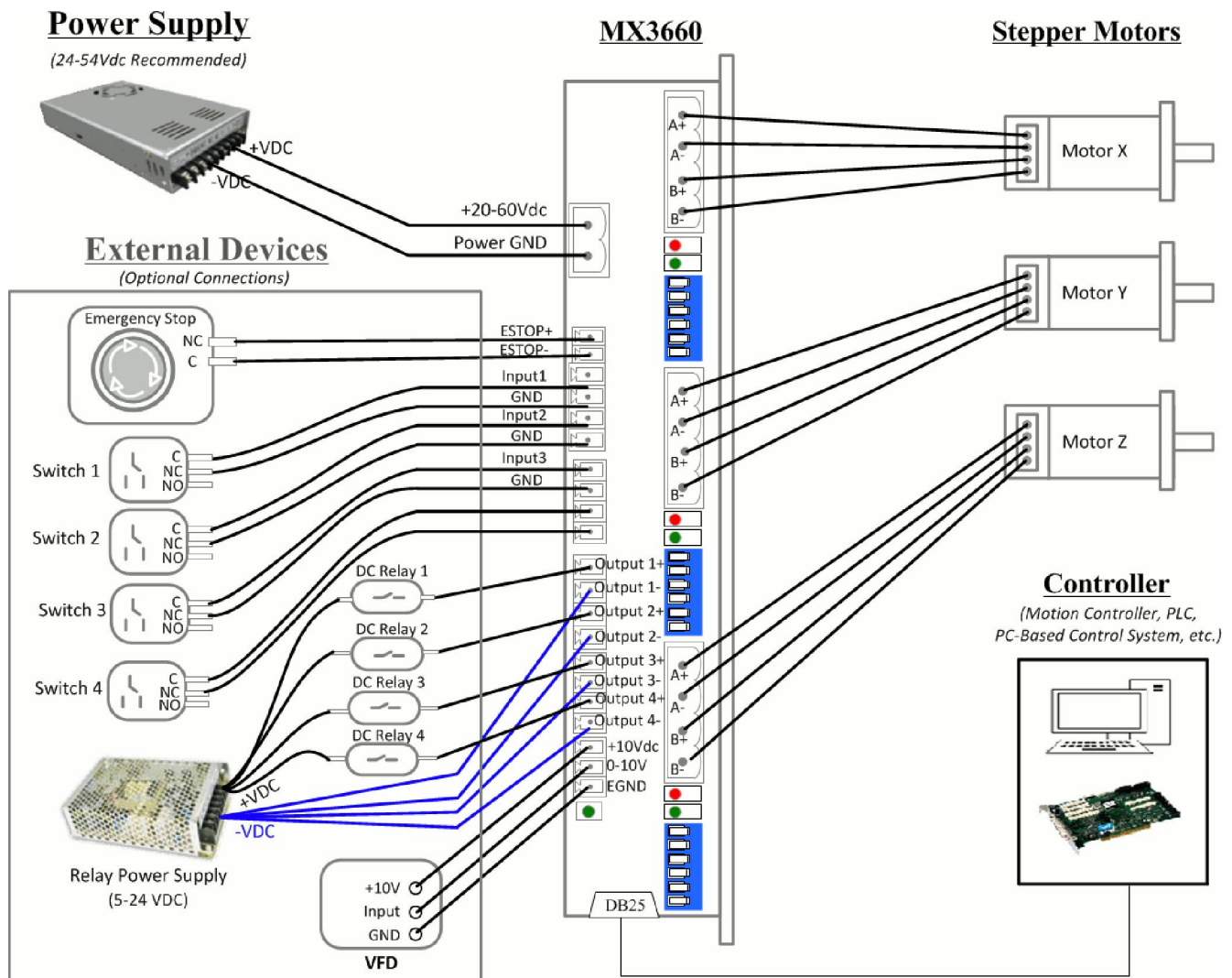

Figure 16 MX3660 Connection Diagram

Appendix B: DB25 Connector Pinout

Figure 17 DB25 connector pin assignments

Pin	Name	Description
1	INPUT 2	<u>General purpose digital input.</u> It is connected to “Output 2” of the digital output connector (CN7 on Figure 3). Used to forward an input signal sent from the connected motion controller to the device connected at “Output 2”.
2	X-AXIS STEP	<u>Input step signal</u> for the X-axis stepper drive board.
3	X-AXIS DIRECTION	<u>Input direction signal</u> for the X-axis stepper drive board.
4	Y-AXIS STEP	<u>Input step signal</u> for the Y-axis stepper drive board.
5	Y-AXIS DIRECTION	<u>Input direction signal</u> for the Y-axis stepper drive board.
6	Z-AXIS STEP	<u>Input step signal</u> for the Z-axis stepper drive board.
7	Z-AXIS DIRECTION	<u>Input direction signal</u> for the Z-axis stepper drive board.
8	INPUT 3	<u>General purpose digital input.</u> It is connected to “Output 3” of the digital output connector (CN7 on Figure 3). Used to forward an input signal sent from the connected motion controller to the device connected at “Output 3”.
9	INPUT 4	<u>General purpose digital input.</u> It is connected to “Output 4” of the digital output connector (CN7 on Figure 3). Used to forward an input signal sent from the connected motion controller to the device connected at “Output 4”.
10	OUTPUT 1	<u>General purpose digital output.</u> It is connected to “Input 1” of the digital input connector (CN6 on Figure 3). Used to forward an output signal from the device connected at “Input 1”, to the motion controller.
11	OUTPUT 2	<u>General purpose digital output.</u> It is connected to “Input 2” of the digital input connector (CN6 on Figure 3). Used to forward an output signal from the device connected at “Input 2”, to the motion controller.
12	OUTPUT 3	<u>General purpose digital output.</u> It is connected to “Input 3” of the digital input connector (CN6 on Figure 3). Used to forward an output signal sent from the device connected at “Input 3”, to the motion controller.
f13	OUTPUT 4	<u>General purpose digital output.</u> It is connected to “Input 4” of the digital input connector (CN6 on Figure 3). Used to forward an output signal sent from the device connected at “Input 4”, to the motion controller.
14	PWM	<u>PWM pulse input.</u> Used to get the PWM signal from the controller which will be then transformed into an analog signal to an external device connected at “0-10 DC” pin of the analog output connector (Figure 3), such as a VFD for spindle speed control.
15	FAULT	<u>Fault signal output</u> back to a motion controller. It will be activated (voltage high) when one of the following events occurs: (1) a signal from ESTOP; (2) any of the 3 built stepper drive modules fails, or is activated for protection.

Pin	Name	Description
16	CHARGE PUMP	<u>General digital input</u> . A watchdog timer to enable/disable MX3660. When “Pulse Switch” (Figure 3) is set to “OFF” position (Charge pump feature not turned off), the MX3660 will be only enabled with 10 KHz signal receiving at this PIN. Otherwise (no such signal received), MX3660 will be disabled. For example, in Mach3 controlled CNC applications, MX3660’s enabling/disabling will depend on the receiving of “Charge Pump” signal from Mach 3.
17	INPUT 1	<u>General purpose digital input</u> . It is connected to “Output 1” of the digital output connector (CN7 on Figure 3). Used to forward an input signal sent from the connected motion controller to the device connected at “Output 1”.
18	GND	Ground
19	GND	Ground
20	GND	Ground
21	GND	Ground
22	GND	Ground
23	GND	Ground
24	GND	Ground
25	GND	Ground

Appendix C: Digital Inputs

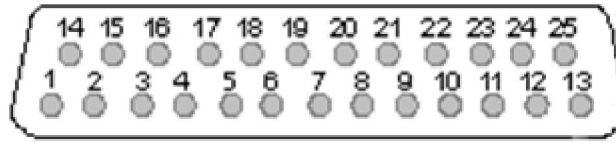
Name	Description
Estop+	<u>Emergency stop input</u> (12V Sourcing). When activated, all three drive boards will be shut down and MX3660 will stop working. The red LED of each drive module will blink three times periodically every 4 seconds to indicate an emergency event signal received. In this case, a fault output will be sent to pin 15 - "Fault"- of the DB25 connector to notify the connected motion controller.
Estop-	Common ground
Input 1	<u>General purpose Input</u> (12V sourcing). This pin is connected to pin 10 - "Output 1" - of the DB25 connector. Used to forward the digital output signal, sent from the connected external device here, to the motion controller connected through the DB25 connector.
GND	Common ground
Input 2	<u>General purpose Input</u> (12V sourcing). This pin is connected to pin 10 - "Output 2" - of the DB25 connector. Used to forward the digital output signal, sent from the connected external device here, to the motion controller connected through the DB25 connector.
GND	Common ground
Input 3	<u>General purpose Input</u> (12V sourcing). This pin is connected to pin 10 - "Output 3" - of the DB25 connector. Used to forward the digital output signal, sent from the connected external device here, to the motion controller connected through the DB25 connector.
GND	Common ground
Input 4	<u>General purpose Input</u> (12V Sourcing). This pin is connected to pin 13 - "Output 4" - of the DB25 connector. Used to forward the digital output signal, sent from the connected external device here, to the motion controller connected through the DB25 connector.
GND	Common ground

Appendix D: Digital Outputs

Name	Description
Output 1 +	<u>General purpose output</u> (max 24V@70mA). This pin is connected to pin 17 - "Input 1" - of the DB25 connector. Used to output the digital signal, sent through DB25 "Input 1" from the motion controller, to the connected external device here.
Output 1-	<u>General purpose output -</u> for Output 1
Output 2 +	<u>General purpose output</u> (max 24V@70mA). The pin is connected to pin 1 - "Input 2" - of the DB25 connector. Used to output the digital signal, sent through DB25 "Input 2" from the motion controller, to the connected external device here.
Output 2-	<u>General purpose output -</u> for Output 3
Output 3 +	<u>General purpose output</u> (max 24V@70mA). This pin is connected to pin 8 - "Input 3" - of the DB25 connector. Used to output the digital signal, sent through DB25 "Input 3" from the motion controller, to the connected external device here.
Output 3-	<u>General purpose output -</u> for Output 3
Output4 +	<u>General purpose output</u> (max 24V@70mA). This pin is connected to pint 9 - "Input 4" - of the DB25 connector. Used to output the digital signal, sent through DB25 "Input 4" from the motion controller, to the connected external device here.
Output 4-	<u>General purpose output -</u> for Output 4

Appendix E: Opto-Isolated Analog Output

Name	Description
+10V	Power source connection pin for the connected analog external device (e.g. VFD), connected at the analog output connector. Voltage range of 5-15VDC.
0-10V	Voltage output to control the external analog device. The powered voltage is 0 to <u>supplied power voltage minus 1.1 VDC</u> . This pin is used to control the external analog device by the controller through PWM signals accepted at PIN 14 of the DB25 connector. Read pin 14 - "PWM" - of the DB25 Connector for more information.
EGND	External +10V ground

Appendix F: Stepper Drive Module Replacement

In the case that one of the three stepper drive modules of the MX3660 does not work (the green LED light is not on when the MX3660 is powered on) you can replace it with a Leadshine SDM660 stepper drive module. Contact us for getting a new SDM660.

Appendix G: Warranty Information

The MX3660 3-axis stepper drive comes with 12-month limited warranty under proper use. Contact your MX3660 supplier first for warranty service. If your MX3660 was bought through Leadshine or one of its subsidiaries, contact us directly.

Appendix H: Trouble Shooting

In the case that the MX3660 doesn't operate properly, the first step is to identify whether the problem is electrical or mechanical in nature. The next step is to isolate the system component that is causing the problem. As part of this process you may have to disconnect the individual components that make up your system and verify that they operate independently. It is important to document each step in the troubleshooting process. You may need this documentation to refer back to at a later date, and these details will greatly assist our Technical Support staff in determining the problem should you need assistance.

Many of the problems that affect motion control systems can be traced to electrical noise, controller software errors, or mistakes in wiring.

The following table shows some commonly asked symptoms and possible solutions.

Symptoms	Possible Cause	Solution
A motor doesn't move	No power	Connect Power
	Wrong signal and / or stepper motor connection	Correct the DB25 connector and / or stepper motor connection(s)
	No E-Stop connection	Option 1: connect an E-Stop switch. Or, Option 2: short "E-Stop +" and "E-Stop+" pins
	The stepper drive modules is under protection	Make sure the power supply voltage is not too high. Also look into your mechanic systems and make sure it does not cause over current protection.
	Control signal voltage is too low	Increase step width.
Motor spins in wrong direction	Wrong motor wiring	Reverse wires on one phase of the stepper motor
Loss of steps	Wrong step enabling setting in your controller	By default, MX3660 step enabling is "Active High". Change your step enabling configuration of your controller to "Active High" also.
	Direction set up time is too short	Increase the direction set up time in your controller to at least two times of pulse width
	Interference	Shield your signal cables and keep the MX3660 as far as possible, from other electronic components

Appendix F: Trouble Shooting (Continued)

Symptoms	Possible Cause	Solution
The red LED light of a stepper drive module blinks	Power supply voltage is too high	Use a lower voltage power supply (24-54 VDC)
	No E-Stop connection	Option 1: connect an E-Stop switch. Or, Option 2: short "E-Stop +" and "E-Stop+" pins
	Damaged stepper motor	Replace your stepper motor
	Over current protection caused by mechanic system	Check and fix the mechanic problem(s) from your mechanic system.
	Acceleration is too fast.	During deceleration, back EMF voltage charge has enabled drive "Over Voltage" protection. Lower down you acceleration/deceleration.
Excessive motor and drive heating	Load is too high	Use a larger motor or motors
	Mechanic problem	Check your mechanic system
	Bad heating dissipation	Add a fan or other device to improve air circulation
The green light of a drive module is not on	That stepper drive module is already damaged	Contact Leadshine for a new stepper drive module for replacement

Contact Us

Contact Leadshine HQ, Leadshine USA Inc., or your local authorized Leadshine distributors for sales, technical support, and other services.

Leadshine Headquarters

Address: 3/F, Block 2
 Nanyou Tianan Industrial Park
 Nanshan District, Shenzhen, China
 Tel: 86-400-885-5521
 Fax: 86-755-2640-2718
 Web: www.leadshine.com
 Sales Email: sales@leadshine.com
 Support: tech@leadshine.com

Leadshine America, Inc.

Address: 25 Mauchly, Suite 318
 Irvine, CA 92608
 USA
 Tel: 1-949-608-7270
 Fax: 1-949-608-7298
 Web: www.leadshineusa.com
 Sales Email: sales@leadshineusa.com
 Support: support@leadshineusa.com