

User Manual for EL5 Servo



Introduction

Thanks for purchasing Leadshine EL5-series AC servo drivers, this instruction manual provides knowledge and attention for using this driver.

Incorrect operation may cause unexpected accident, please read this manual carefully before using product.

- ◇ We reserve the right to modify equipment and documentation without prior notice.
- ◇ We won't undertake any responsibility with customer's any modification of product, and the warranty of product will be cancel at the same time.

Be attention to the following warning symbol:



indicates that the error operation could result in loss of life or serious injury.



indicates that the error operation could result in operator injured, also make equipment damaged.



indicates that the error use may damage product and equipment.

Safety precautions



- The design and manufacture of product doesn't use in mechanic and system which have a threat to operator.
- The safety protection must be provided in design and manufacture when using this product to prevent incorrect operation or abnormal accident.

Acceptance



- The product which is damaged or have fault is forbidden to use.

Transportation



- The storage and transportation must be in normal condition.
- Don't stack too high, prevent falling.
- The product should be packaged properly in transportation,
- Don't hold the product by the cable, motor shaft or encoder while transporting it.
- The product can't undertake external force and shock.

Installation



Servo Driver and Servo Motor:

- Don't install them on inflammable substance or near it to preventing fire hazard.
- Avoid vibration, prohibit direct impact.
- Don't install the product while the product is damaged or incomplete.

Servo Driver:

- Must install in control cabinet with sufficient safeguarding grade.
- Must reserve sufficient gap with the other equipment.
- Must keep good cooling condition.
- Avoid dust, corrosive gas, conducting object, fluid and inflammable ,explosive object from invading.

Servo Motor:

- Installation must be steady, prevent drop from vibrating.
- Prevent fluid from invading to damage motor and encoder.
- Prohibit knocking the motor and shaft, avoid damaging encoder.
- The motor shaft can't bear the load beyond the limits.

Wiring



- The workers of participation in wiring or checking must possess sufficient ability do this job.
- The wiring and check must be going with power off after five minutes
- Ground the earth terminal of the motor and driver without fail.
- The wiring should be connected after servo driver and servo motor installed correctly
- After correctly connecting cables, insulate the live parts with insulator.



- The wiring must be connected correctly and steadily, otherwise servo motor may run incorrectly, or damage the equipment .
- Servo motor U, V, W terminal should be connected correctly , it is forbidden to connect them directly to AC power.
- We mustn't connect capacitors ,inductors or filters between servo motor and servo driver .
- The wire and temperature-resistant object must not be close to radiator of servo driver and motor.
- The freewheel diode which connect in parallel to output signal DC relay mustn't connect reversely.

Debugging and running

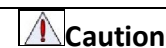

- Make sure the servo driver and servo motor installed properly before power on, fixed steadily, power voltage and wiring correctly.
- The first time of debugging should be run without loaded, debugging with load can be done after confirming parameter setting correctly, to prevent mechanical damage because of error operation.

Using

 **Caution**

- Install a emergency stop protection circuit externally, the protection can stop running immediately to prevent accident happened and the power can be cut off immediately.
- The run signal must be cut off before resetting alarm signal, just to prevent restarting suddenly.
- The servo driver must be matched with specified motor.
- Don't power on and off servo system frequently, just to prevent equipment damaged.
- Forbidden to modify servo system.

Fault Processing

 **Warning**

- The high voltage also will contain in several minutes even if the servo driver is powered off, please don't touch terminal strip or separate the wiring.
- The workers of participation in wiring or checking must possess sufficient ability do this job.

 **Caution**

- The reason of fault must be figured out after alarm occurs, reset alarm signal before restart.
- Keep away from machine, because of restart suddenly if the driver is powered on again after momentary interruption(the design of the machine should be assured to avoid danger when restart occurs)

System selection

 **Attention**

- The rate torque of servo motor should be larger than effective continuous load torque.
- The ratio of load inertia and motor inertia should be smaller than recommended value.
- The servo driver should be matched with servo motor.

Table of Contents

User Manual for EL5 Servo	1
Introduction	2
Chapter 1 Introduction	7
1.1 Product Introduction	7
1.2 Inspection of product	7
1.3 Product Appearance	7
Chapter 2 Installation	9
2.1 Storage and Installation Circumstance	9
2.2 Servo Driver Installation	9
2.2.1 Installation Method	9
2.2.2 Installation Space	11
2.3 Servo Motor Installation	12
Chapter 3 Wiring	13
3.1 Wiring	13
3.1.1 Wire Gauge	13
3.1.2 Position Control Mode	14
3.1.3 Torque /Velocity Control Mode	15
3.2 Driver Terminals Function	15
3.2.1 Control Signal Port-CN1 Terminal	15
3.2.2 Encoder Input Port-CN2 Terminal	18
3.2.3 Communication Port	18
3.2.4 Power Port	19
3.3 I/O Interface Principle	19
3.3.1 Switch Input Interface	19
3.3.2 Switch Output Interface	20
3.3.3 Pulse Input Interface	20
3.3.4 Analog Value Input Interface	22
3.3.5 Servo Motor Encoder Input Interface	22
Chapter 4 Parameter	23
4.1 Parameter List	23
4.2 Parameter Function	26
4.2.1 【Class 0】 Basic Setting	26
4.2.2 【Class 1】 Gain Adjust	29
4.2.3 【Class 2】 Vibration Suppression	33
4.2.4 【Class 3】 Velocity/ Torque Control	34
4.2.5 【Class 4】 I/F Monitor Setting	39
4.2.6 【Class 5】 Extended Setup	43
4.2.7 【Class 6】 Special Setup	46
Chapter 5 Alarm and Processing	47
5.1 Alarm List	47
5.2 Alarm Processing Method	48
Chapter 6 Display and Operation	54

6.1 Introduction	54
6.2 Panel Display and Operation.....	55
6.2.1 Panel Operation Flow Figure.....	55
6.2.2 Driver Operating Data Monitor	55
6.2.3 System Parameter Setting Interface.....	58
6.2.4 Auxiliary Function.....	61
6.2.5 Saving parameter	62
6.2.6 Abnormal Alarm	63
Chapter 7 Trial Run	64
7.1 Inspection Before trial Run	64
7.1.1 Inspection on wiring.....	64
7.1.2 Timing chart on power-up	65
7.1.3 Timing chart on fault	65
7.1.4 holding brake.....	65
7.2 Trial Run.....	66
7.2.1 Jog Control	66
7.2.2 Position Control.....	67
7.2.3 Velocity Control.....	68
7.2.4 Torque Control.....	69
7.3 Automatic Control Mode Run	71
7.3.1 Operation Mode Selection.....	71
7.3.2 Position Mode.....	71
7.3.3 Velocity Mode	74
7.3.4 Torque Mode	77
Chapter 8 Product Specification	80
8.1 Driver Technical Specification	80
8.2 Accessory selection	81
Chapter 9 Order Guidance.....	81
9.1 Capacity Selection.....	81
9.2 Electronic Gear Ratio	81
Appendix	82
<i>How to debug the parameter of driver matched with different servo motor.....</i>	82
Contact us.....	83

Chapter 1 Introduction

1.1 Product Introduction

Since early 1990s, AC servo technology has been improved, AC servo is now widely used in the field of CNC machine tools, printing and packaging machinery, textile machinery, and automated production line automation.

The EL5 series AC servo motor & driver is the latest servo system that's meets all demands for a variety of machines which require high speed, high precision and high performance or which require simplified settings.

Talent feature:

◆ Width ratio, constant torque

Speed ratio : 1:5000, stable torque features from low speed to high speed

◆ High-speed, high-precision

The maximum speed of the servo motor up to 5000rpm, rotation positioning accuracy up to $1/2^{17}$ r.

◆ Simple, flexible to control

By modifying the parameters of the servo system, the operating characteristics make the appropriate setting to suit different requirements.

1.2 Inspection of product

1. You must check the following thing before using the products :

- a. Check if the product is damaged or not during transportation.
- b. Check if the servo driver & motor are complete or not.
- c. Check the packing list if the accessories are complete or not

2. Type meaning

- a. EL5 series servo driver

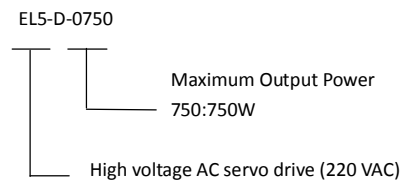

- b. Servo motor type

The EL5 series AC servo driver can be matched with a variety of domestic and foreign servo motor.

1.3 Product Appearance

1. EL5 series AC servo driver appearance:



2. Servo motor appearance:

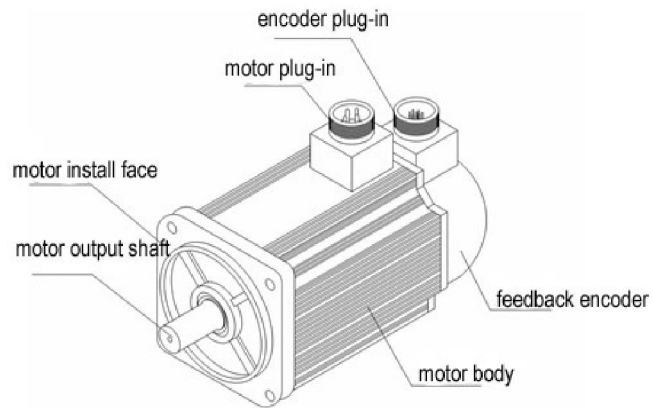

3. Accessory

EL5 series servo driver standard accessories

- a. user manual
- b. CN1 connector (DB44)
- c. CN2 plug (DB15 pin)

[[Note]] : The ACH series driver supports the PC debugging software which can be downloaded from our website

Chapter 2 Installation

2.1 Storage and Installation Circumstance

Table 2.1 Servo Driver, Servo Motor Storage Circumstance Requirement

Item	EL5 series driver	EL5 servo motor
Temperature	-20-80℃	-25-70℃
Humidity	Under 90%RH (free from condensation)	Under 80%RH (free from condensation)
Atmospheric environment	Indoor (no exposure) no corrosive gas or flammable gas, no oil or dust	Indoor (no exposure) no corrosive gas or flammable gas, no oil or dust
Altitude	Lower than 1000m	Lower than 2500m
Vibration	Less than 0.5G (4.9m/s ²) 10-60Hz (non-continuous working)	
Protection level	IP00 (no protection)	IP65

Table 2.2 Servo Driver, Servo Motor Installation Circumstance Requirement

Item	EL5 series driver	EL5 servo motor
Temperature	0-55℃	-25-40℃
Humidity	Under 90%RH (free from condensation)	Under 90%RH (free from condensation)
Atmospheric environment	Indoor (no exposure) no corrosive gas or flammable gas, no oil or dust	Indoor (no exposure) no corrosive gas or flammable gas, no oil or dust
Altitude	Lower than 1000m	Lower than 2500m
Vibration	Less than 0.5G (4.9m/s ²) 10-60Hz (non-continuous working)	
Protection level	IP00 (no protection)	IP65

2.2 Servo Driver Installation



- Must install in control cabinet with sufficient safeguarding grade.
- Must install with specified direction and intervals, and ensure good cooling condition.
- Don't install them on inflammable substance or near it to prevent fire hazard.

2.2.1 Installation Method

Install in vertical position, and reserve enough space around the servo driver for ventilation. Here is the installation diagram:

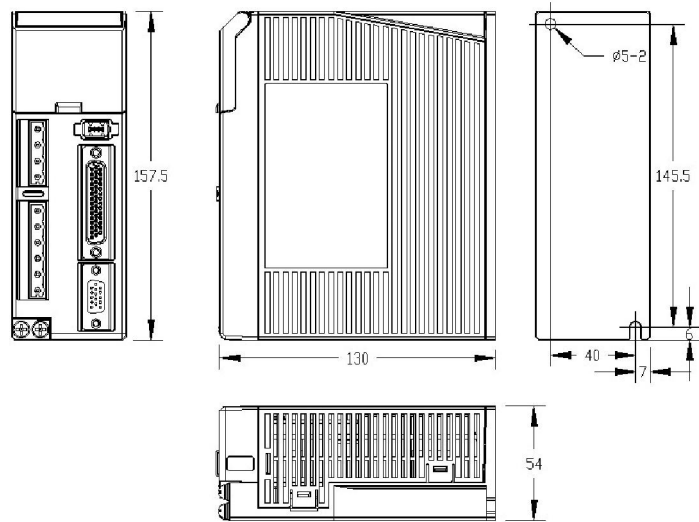

Figure 2.1 installation method of driver EL5-D-400

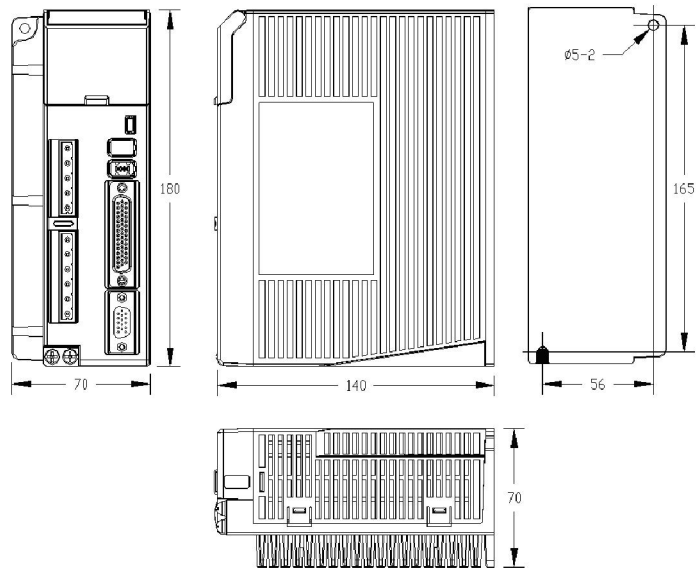

Figure 2.2 installation method of driver EL5-D-750

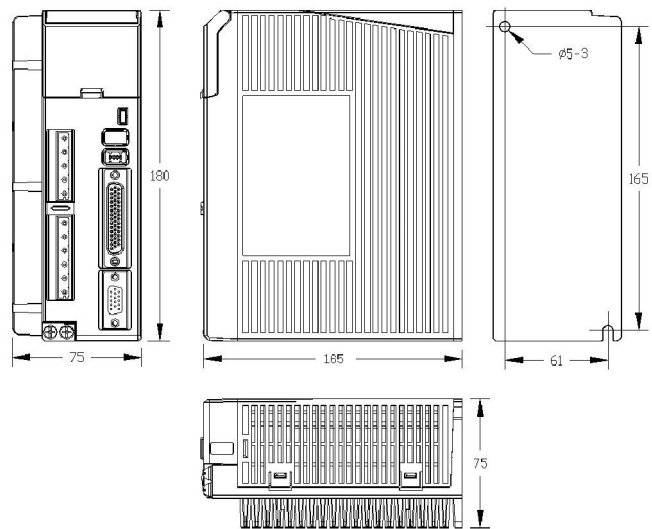

Figure 2.3 installation method of driver EL5-D-1000/EL5-D-1500

2.2.2 Installation Space

Reserve enough surrounding space for effective cooling.

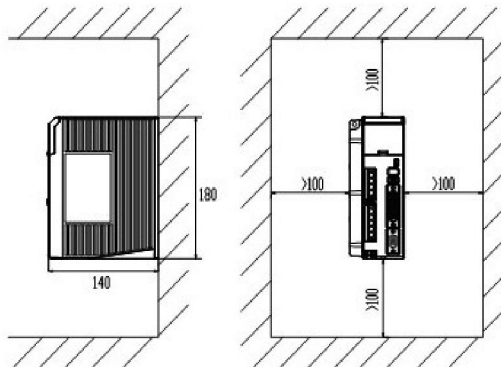

Figure 2-4 Installation Space for Single Driver

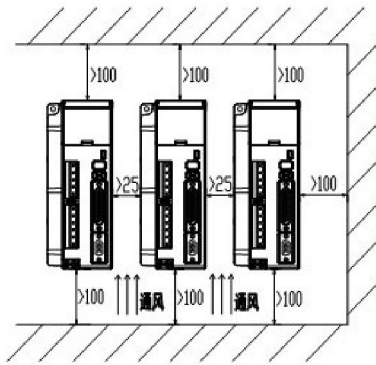

Figure 2-5 Installation Space for several Drivers

2.3 Servo Motor Installation

Notice

- Don't hold the product by the cable, motor shaft or encoder while transporting it.
- No knocking motor shaft or encoders, prevent motor by vibration or shock.
- The motor shaft can't bear the load beyond the limits.
- Motor shaft does not bear the axial load, radial load, otherwise you may damage the motor.
- Use a flexible with high stiffness designed exclusively for servo application in order to make a radial thrust caused by micro misalignment smaller than the permissible value.
- Install must be steady, prevent drop from vibrating.

Chapter 3 Wiring

 **Warning**

- The workers of participation in wiring or checking must possess sufficient ability do this job.
- The wiring and check must be going with power off after five minutes.

 **Caution**

- Ground the earth terminal of the motor and driver without fail.
- The wiring should be connected after servo driver and servo motor installed correctly

3.1 Wiring

3.1.1 Wire Gauge

(1) Power supply terminal TB

- Diameter: R, S, T, PE, U, V, W terminals diameter $\geq 1.5\text{mm}^2$ (AWG14-16), r, t terminal diameter $\geq 1.0\text{mm}^2$ (AWG16-18).

- Grounding: The grounding wire should be as thick as possible, drive servo motor the PE terminal point ground, ground resistance $<100\ \Omega$.
- Use noise filter to remove external noise from the power lines and reduce an effect of the noise generated by the servo driver.
- Install fuse (NFB) promptly to cut off the external power supply if driver error occurs.

(2) The control signal CN1 feedback signal CN2

- Diameter: shielded cable (twisting shield cable is better), the diameter $\geq 0.12\text{mm}^2$ (AWG24-26), the shield should be connected to FG terminal.
- Length of line: cable length should be as short as possible and control CN1 cable is no more than 3 meters, the CN2 cable length of the feedback signal is no more than 20 meters.
- Wiring: be away from the wiring of power line, to prevent interference input.
- Install a surge absorbing element for the relevant inductive element (coil); DC coil should be in parallel connection with freewheeling diode reversely; AC coil should be in parallel connection with RC snubber circuit.

 **Attention**

- Match the colors of the motor lead wires to those of the corresponding motor output terminals (U.V.W)
- Never start nor stop the servo motor with this magnetic contactor.
- Cable must be fixed steadily, avoid closing to radiator and motor to prevent reducing the properties of heat insulation

3.1.2 Position Control Mode

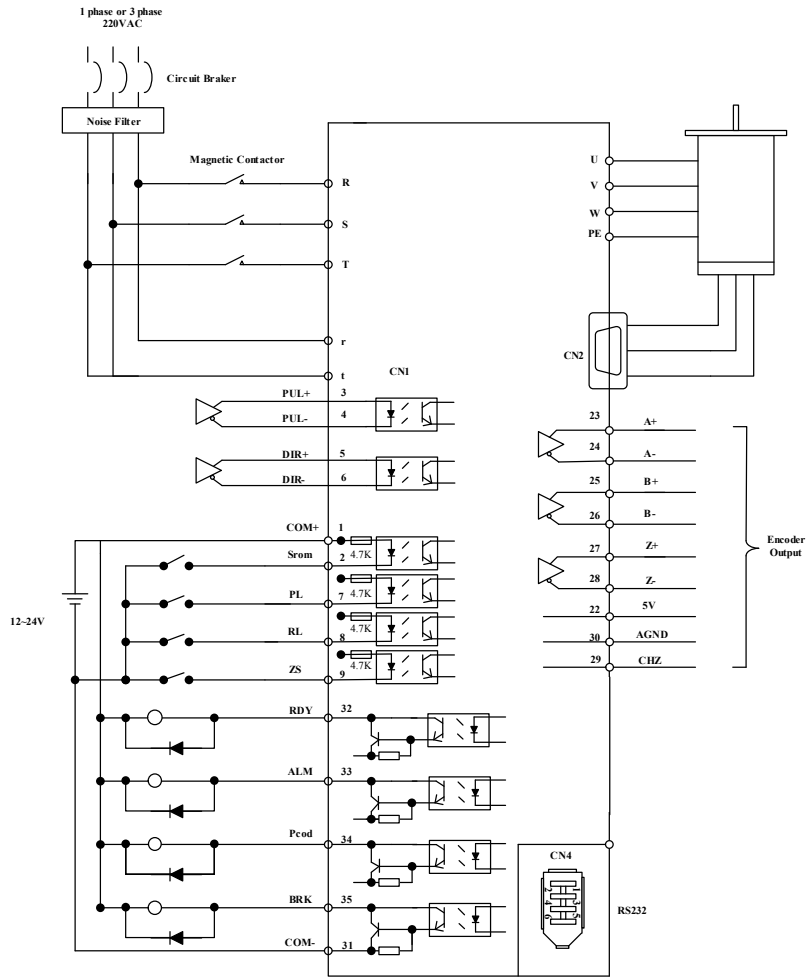

Figure 3-1 Positional Control Mode Wiring

3.1.3 Torque /Velocity Control Mode

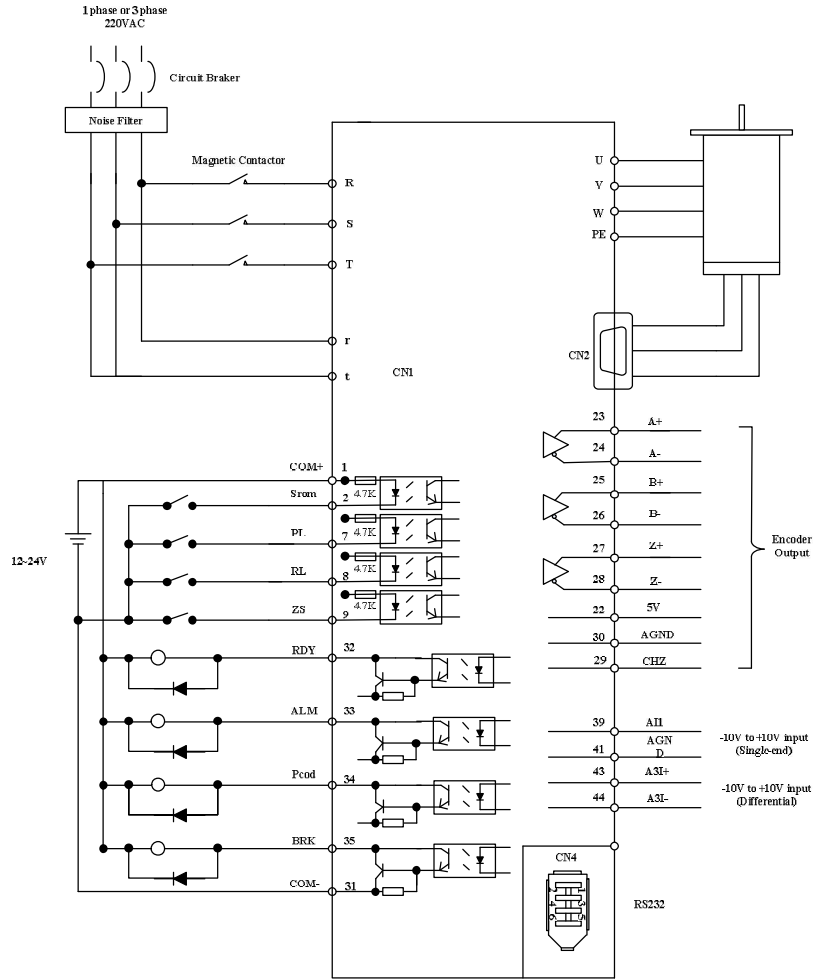

Figure 3-2 Torque/Velocity Control Mode Wiring

3.2 Driver Terminals Function

3.2.1 Control Signal Port-CN1 Terminal

The left on Figure 3.3 is control signal port CN1 of servo driver with DB44 connector; And, the right on

Figure 3.3 is SI input of the switch, SO output of the switch, analog A1 input, the A3 input from top to bottom.

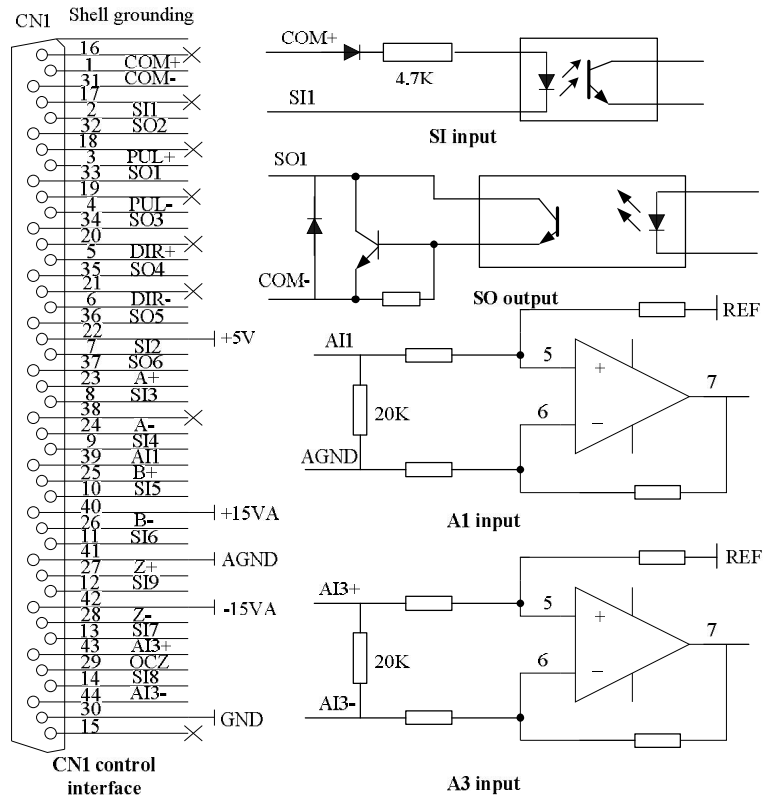

Figure 3-3 Servo Driver Port Terminal

Table 3.1 Signal Explanation of Control Signal Port-CN1

Pin No	Signal	Input/output	Name and Explanation
1	COM+	input	power supply positive terminal of the external input control signal, 12V ~ 24V
2	SI1	input	Digital input signal 1, default value is servo on signal in position mode , low level available in default , the maximum voltage is 24V input
3	PUL+	input	positive and negative pulse input, respectively. TTL level (5V), the rising edge available in default
4	PUL-	input	positive and negative pulse input, respectively. TTL level (5V), the rising edge available in default
5	DIR+	input	positive and negative direction input, respectively. TTL level (5V), optical coupling deadline available in default
6	DIR-	input	positive and negative direction input, respectively. TTL level (5V), optical coupling deadline available in default
7	SI2	input	Digital input signal 2, default value is forward run prohibited (POT)signal in position mode ,high level available in default , the maximum voltage is 24V input
8	SI3	input	Digital input signal 3, default value is reverse run prohibited (NOT) signal in position mode , high level available in default , the maximum voltage is 24V input
9	SI4	input	Digital input signal 4, default value is zero-speed clamp (ZEROSPD) signal in position mode ,high level available in

			default , the maximum voltage is 24V input	
10	SI5	input	Digital input signal 5, default value is deviation counter clear input in position mode , low level available in default , the maximum voltage is 24V input	
11	SI6	input	Digital input signal 6, low level available in default , the maximum voltage is 24V input	
12	SI9	input	Digital input signal 9, low level available in default , the maximum voltage is 24V input	
13	SI7	input	Digital input signal 7, low level available in default , the maximum voltage is 24V input	
14	SI8	input	Digital input signal 8, low level available in default , the maximum voltage is 24V input	
22	+5V	output	Reserved, encoder signal output +5V	
23	A+	output	Positive/negative differential output terminal of motor encoder A phase	
24	A-	output		
25	B+	output		
26	B-	output		
27	Z+	output	Positive/negative differential output terminal of motor encoder Z phase	
28	Z-	output		
29	OCZ	output	Z signal OC output	
30	GND	output	Power ground of encoder signal output	
31	COM-	output	Digital output signal commonality ground	
32	SO2	output	Digital output signal 2 , default value is servo ready output (S-RDY) in position mode , low level available in default	Low resistor output in default . OC, the maximum voltage/current is no more than 30V, 50mA . Recommend the voltage : 12 V-24V. Current : 10mA
33	SO1	output	Digital output signal 1 , default value is alarm output (ALM) in position mode , high level available in default	
34	SO3	output	Digital output signal 3 , default value is positioning complete (INP) in position mode , high level available in default	
35	SO4	output	Digital output signal 4, default value is external brake release output (BRK-OFF) in position mode , low level available in default	
36	SO5	output	Digital output signal 5	
37	SO6	output	Digital output signal 6	
39	AI1	input	Analog input 1, voltage input range : -10 - 10V , input resistor 20K Ω	
40	+15VA	output	Reserved, output voltage:15V, current : less than 50mA	
41	GND1 5VA	output	Reserve,+15V ground	
43	AI3+	input	The positive/ negative terminal of analog input 3, voltage input range -10-10V, input resistor : 20K Ω	
44	AI3-	input		
15-21, 38,42	NC	/	Not connection	
Shell	FG	/	Shield ground	

3.2.2 Encoder Input Port-CN2 Terminal

Table 3.2 Encoder Input Port-CN2 Terminal Signal Explain

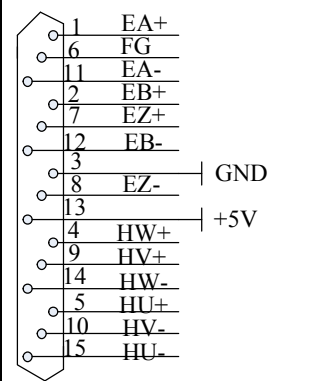
Pin	Signal	Name	Terminal Arrangement Figure
1	EA+	Encoder channel A+ input	
2	EB+	Encoder channel B+ input	
3	EGND	Signal ground	
4	Hall W+	Hall sensor W+ input	
5	Hall U+	Hall sensor U+ input	
6	FG	Ground terminal for shielded	
7	EZ+	Encoder channel Z+ input	
8	EZ-	Encoder channel Z- input	
9	Hall V+	Hall sensor V+ input	
10	Hall V-	Hall sensor V- input	
11	EA-	Encoder channel A- input	
12	EB-	Encoder channel B- input	
13	VCC	+5V for encoder power supply	
14	Hall W-	Hall sensor W- input	
15	Hall U-	Hall sensor U- input	

3.2.3 Communication Port

Table 3.3 Signal Explanation of connection and debugging Port-CN4

RS232	connect PC or STU using dedicated series cable, prohibited to insert if power on. and suggest to use twisted-pair or shielded wire. the length of wire is less than 2 meter	
RS485	Recommend shield twisted-pair.	
Terminal	signal	name
1	GND	Power ground
2	TxD	sending terminal of RS232
3	5V	Reserved, the current is less than 50mA
4	RxD	received terminal of RS232
5	RS485+	Reserve,RS485+/A
6	RS485-	Reserve,RS485-/B

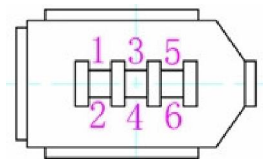
Table 3.4 signal explanation of driver interconnection interface-CN3

RS485	Recommend shield twisted-pair.	
Terminal	signal	name
1	GND	Power ground
2	NC	Not connect
3	5V	Reserve, the current is less than 50mA
4	NC	Not connect
5	RS485+	Reserve,RS485+/A
6	RS485-	Reserve,RS485-/B

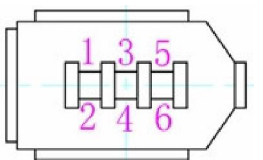

3.2.4 Power Port

Table 3.5 Main Power Input Port-CN5

Terminal	Signal	Name	
1	R	the main power input: connecting 3-phase 220Vac or single phase 220Vac, For single phase 220V ,recommend to connect to the R and T.	
2	S		
3	T		
4	BR	Outside brake resistor input terminal	external brake resistor connect between BR1 and P+
5	P+	DC bus voltage+	

Table 3.6 Control Power Input Port-CN6

Terminal	Signal	Name	
1	U	3 phase motor power input	
2	V		
3	W		
4	PE	Frame ground	
5	r	Control power input 1	Control power voltage range between 1 and 2: 85Vac-265Vac
	t	Control power input 2	

3.3 I/O Interface Principle

3.3.1 Switch Input Interface

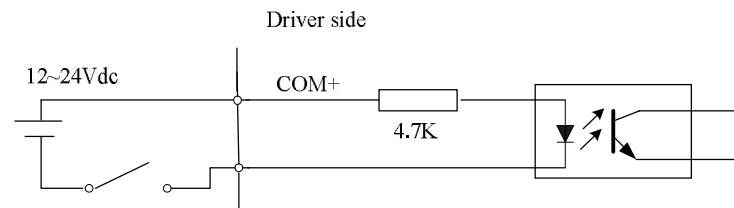
Figure 3-4 Switch Input Interface

- The user provide power supply, DC 12-24V, current $\geq 100\text{mA}$
- **Notice:** if current polar connect reversely, servo driver doesn't run.

3.3.2 Switch Output Interface

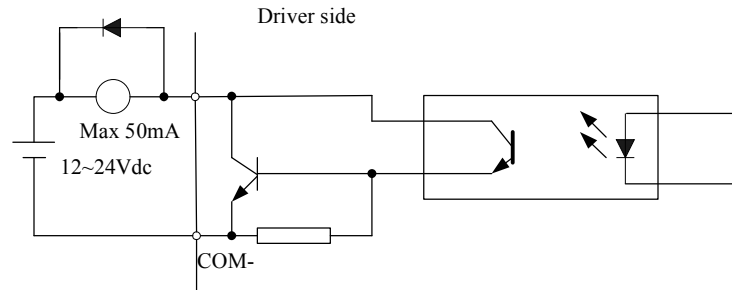

Figure 3.5 Switch Output Interface

- (1) The user provide the external power supply . However, if current polarity connects reversely, servo driver is damaged.
- (2) The output of the form is open-collector, the maximum voltage is 25V, and maximum current is 50mA. Therefore, the load of switch output signal must match the requirements. If you exceed the requirements or output directly connected with the power supply, the servo drive is damaged.
- (3) If the load is inductive loads relays, etc., there must be anti-parallel freewheeling diode across the load. If the freewheeling diode is connected reversely, the servo drive is damaged.

3.3.3 Pulse Input Interface

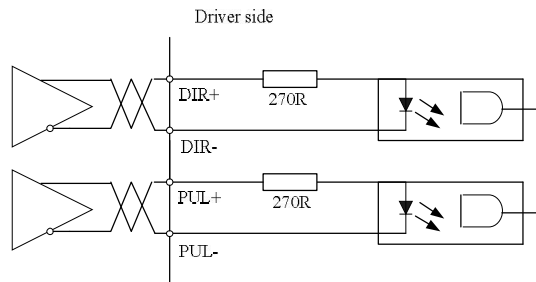
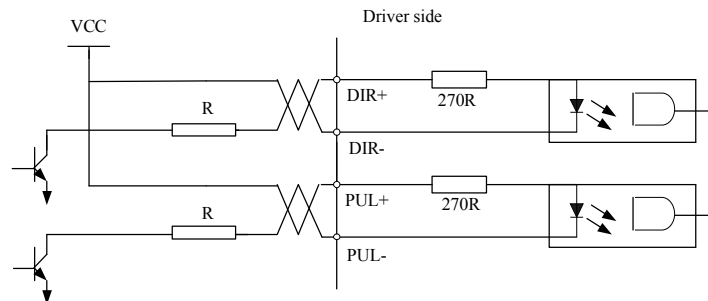

Figure 3-6 Pulse Input Interface Differential Drive Mode



Vcc =12V, R = 1K, 0.25W

Vcc =24V, R = 2K, 0.25W

Figure3-7 Pulse Input Interface Single Terminal Drive Mode

- (1) In order to transmit pulse data properly , we recommend using the differential drive mode.
- (2) The differential drive mode, AM26LS31, MC3487 or similar RS422 line drive.
- (3) Using of single-ended drive will cause reduction of the operation frequency. The value of the resistance R depends on pulse input circuit and the external voltage,while drive current should be at the range of 10 - 15mA and the maximum voltage is no more than 25V .

Recommendation:

VCC = 24V, R = 1.3 to 2KΩ;

VCC = 12V, R = 510 ~ 820Ω;

VCC = 5V, R = 82 ~ 120Ω.

- (4) The user provide external power supply for single-ended drive. However, if current polarity connect reversely, servo driver is damaged. However, if current polarity connects reversely, servo driver is damaged.
- (5) The form of pulse input is the following form 3.7 below, while the arrows indicates the count .

Table 3.7 Pulse Input Form

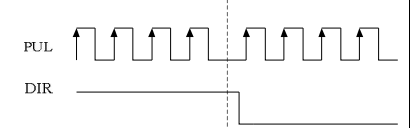
Pulse command form	CCW	CW	Parameter setting value
Pulse symbol			Pulse + direction

The form of pulse input timing parameter is the following form 3.8 below. The 4 times pulse frequency \leq 500kHz if 2-phase input form is used.

Table 3.8 the parameters of pulse input time sequence

parameter	Differential drive input	Single-ended drive input
t_{ek}	$> 2\mu s$	$> 5\mu s$
t_h	$> 1\mu s$	$> 2.5\mu s$
t_l	$> 1\mu s$	$> 2.5\mu s$
t_{rh}	$< 0.2\mu s$	$< 0.3\mu s$
t_{rl}	$< 0.2\mu s$	$< 0.3\mu s$
t_s	$> 1\mu s$	$> 2.5\mu s$
t_{qck}	$> 8\mu s$	$> 10\mu s$
t_{qh}	$> 4\mu s$	$> 5\mu s$
t_{ql}	$> 4\mu s$	$> 5\mu s$
t_{qrh}	$< 0.2\mu s$	$< 0.3\mu s$
t_{qrl}	$< 0.2\mu s$	$< 0.3\mu s$
t_{qs}	$> 1\mu s$	$> 2.5\mu s$

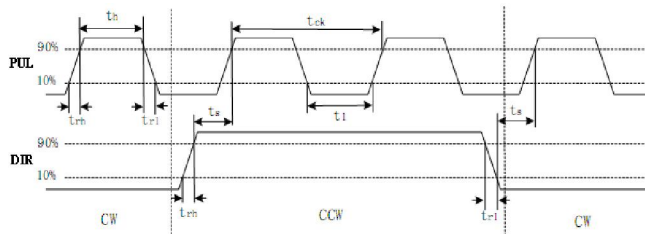

Figure 3.8 pulse + direction input interface timing (the maximum of pulse frequency : 500KHZ)

3.3.4 Analog Value Input Interface

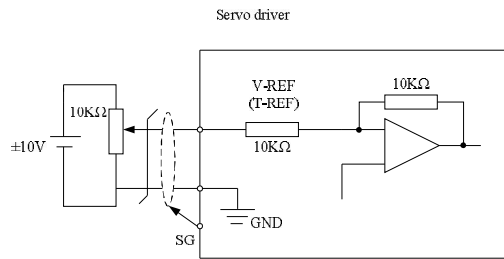

Figure 3-9 Analog AI1 Input Interface

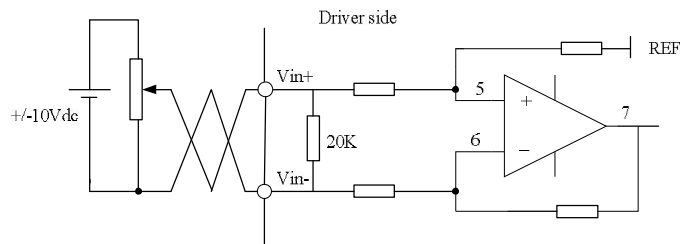

Figure 3-10 Analog AI3 Input Interface

3.3.5 Servo Motor Encoder Input Interface

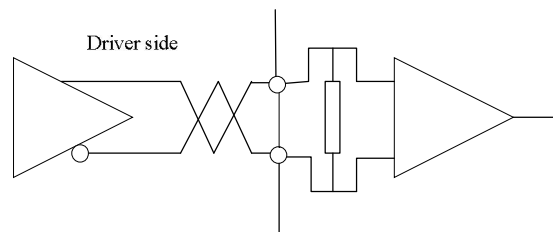

Figure 3-11 Servo Motor optical-electrical Encoder Input Interface

Chapter 4 Parameter

4.1 Parameter List

Mode			Parameter Number		Name	
P	S	T	Classify	Number		
P	S	T	【Class 0】 Basic setting	01	control mode setup	
P	S	T		02	real-time auto-gain tuning	
P	S	T		03	selection of machine stiffness at real-time auto-gain tuning	
P	S	T		04	Inertia ratio	
P				06	command pulse rotational direction setup	
P				07	command pulse input mode setup	
P				09	1st numerator of electronic gear	
P				10	denominator of electronic gear	
P	S	T		11	output pulse counts per one motor revolution	
P	S	T		12	reversal of pulse output logic	
P	S	T		13	1st torque limit	
P				14	position deviation excess setup	
P				【Class 1】 Gain Adjust	00	gain of 1st position loop
P	S	T			01	gain of 1st velocity loop
P	S	T	02		time constant of 1st velocity loop integration	
P	S	T	03		filter of 1st velocity detection	
P	S	T	04		time constant of 1st torque filter	
P			05		gain of 2nd position loop	
P	S	T	06		gain of 2nd velocity loop	
P	S	T	07		time constant of 2nd velocity loop integration	
P	S	T	08		filter of 2nd velocity detection	
P	S	T	09		time constant of 2nd torque filter	
P			10		Velocity feed forward gain	
P			11		Velocity feed forward filter	
P	S		12		Torque feed forward gain	
P	S		13		Torque feed forward filter	
P	S	T	14	2nd gain setup		
P			15	Control switching mode		
P			17	Control switching level		
P			18	Control switch hysteresis		
P			19	Gain switching time		
P			35	Positional command filter setup		
P	S	T	36	Encoder feedback pulse digital filter setup		
P	S		【Class 2】 Vibration	00	adaptive filter mode setup	
P	S	T		01	1st notch frequency	

P	S	T	Restrain Function	02	1st notch width selection	
P	S	T		03	1st notch depth selection	
P	S	T		04	2nd notch frequency	
P	S	T		05	2nd notch width selection	
P	S	T		06	2nd notch depth selection	
P				22	Positional command smooth filter	
P				23	Positional command FIR filter	
	S		【Class 3】 Speed, Torque Control	00	Velocity setup internal/external switching	
	S			01	Speed command rotational direction selection	
	S	T		02	Speed command input gain	
	S			03	Speed command reversal input	
	S			04	1st speed setup	
	S			05	2nd speed setup	
	S			06	3rd speed setup	
	S			07	4th speed setup	
	S			08	5th speed setup	
	S			09	6th speed setup	
	S			10	7th speed setup	
	S			11	8th speed setup	
	S			12	Acceleration time setup	
	S			13	Deceleration time setup	
	S			14	Sigmoid acceleration/deceleration time setup	
				15	Speed zero-clamp function selection	
	S	T		16	Speed zero-clamp level	
		T		18	Torque command direction selection	
		T		19	Torque command input gain	
		T		20	Torque command input reversal	
		T		21	Speed limit value 1	
P	S	T		24	maximum speed of motor rotation	
P	S	T		【Class 4】 I/F Monitor Setting	00	SI 1 input selection
P	S	T			01	SI 2 input selection
P	S	T	02		SI 3 input selection	
P	S	T	03		SI 4 input selection	
P	S	T	04		SI 5 input selection	
P	S	T	10		SO 1 output selection	
P	S	T	11		SO 2 output selection	
P	S	T	12		SO 3 output selection	
P	S	T	13		SO 4 output selection	
P	S	T	22		Analog input 1(AI 1) offset setup	
P	S	T	23		Analog input 1(AI 1) filter	
P	S	T	28		Analog input 3(AI 3) offset setup	
P	S	T	29		Analog input 3(AI 3) filter	
P			31		Positioning complete range	

P				32	Positioning complete output setup	
P				33	INP hold time	
P	S	T		34	Zero-speed	
	S			35	Speed coincidence range	
P	S	T		36	At-speed	
P	S	T		37	Mechanical brake action at stalling setup	
P	S	T		38	Mechanical brake action at running setup	
P	S	T		39	Brake action at running setup	
P			【Class 5】	00	2nd numerator of electronic gear	
P			Extended Setup	01	3rd numerator of electronic gear	
P				02	4th numerator of electronic gear	
P	S	T		03	Denominator of pulse output division	
P	S	T		06	Sequence at servo-off	
P	S	T		08	Main power off LV trip selection	
P	S	T		09	Main power off detection time	
P	S	T		13	Over-speed level setup	
P	S	T		15	I/F reading filter	
P	S	T		28	LED initial status	
P	S	T		29	RS232 baud rate setup	
P	S	T		30	RS485 baud rate setup	
P	S	T		31	Axis address	
P	S	T		35	Front panel lock setup	
P	S	T		【Class 6】	03	JOG trial run command torque
P	S	T		Special Setup	04	JOG trial run command speed
P	S	T			08	Positive direction torque compensation value
P	S	T			09	Negative direction torque compensation value
P					20	distance of trial running
P			21		waiting time of trial running	
P			22		cycling times of trial running	

4.2 Parameter Function

Here is the explanation of parameters ,you can check them or modify the value using software Protuner or the front panel of driver.

4.2.1 【Class 0】 Basic Setting

Pr0.01*	Control Mode Setup	Range	unit	default	Related control mode		
		0 - 2	-	0	P	S	T
Set using control mode							
Setup value	Content		When you set up the combination mode of 3.4.5, you can select either the 1st or the 2nd with control mode switching input(C-MODE). When C-MODE is open, the 1st mode will be selected. When C-MODE is shorted, the 2nd mode will be selected.				
	1st mode	2nd mode					
0	Position	-					
1	Velocity	-					
2	Torque	-					
3	Position	Velocity					
4	Position	Torque					
5	Velocity	Torque					

Pr0.02	Real-time Auto-gain Tuning	Range	unit	default	Related control mode		
		0 - 2	-	0	P	S	T
You can set up the action mode of the real-time auto-gain tuning.							
Setup value	mode	Varying degree of load inertia in motion					
0	invalid	Real-time auto-gain tuning function is disabled.					
1	standard	Basic mode. do not use unbalanced load, friction compensation or gain switching					
2	positioning	Main application is positioning. it is recommended to use this mode on equipment without unbalanced horizontal axis, ball screw driving equipment with low friction, etc.					
Caution: If pr0.02=1 or 2 , you can't modify the values of pr1.01 – pr1.13, the values of them depend on the real-time auto-gain tuning ,all of them are set by the driver itself.							

Pr0.03	selection of machine stiffness at real time auto gain tuning	Range	unit	default	Related control mode		
		0 - 31	-	11	P	S	T
You can set up response while the real-time auto-gain tuning is valid.							
Low → Machine stiffness → High Low → Servo gain → High <div style="border: 1px solid black; padding: 5px; display: inline-block; margin: 10px 0;"> 0.1.....11.12.13.....30.31 </div> Low → Response → High							
Notice: Higher the setup value, higher the velocity response and servo stiffness will be obtained. However, when increasing the value, check the resulting operation to avoid oscillation or vibration. Control gain is updated while the motor is stopped. If the motor can't be stopped due to excessively low gain or continuous application of one-way direction command ,any change made to Pr0.03 is not							

used for update. If the changed stiffness setting is made valid after the motor stopped, abnormal sound or oscillation will be generated. To prevent this problem, stop the motor after changing the stiffness setting and check that the changed setting is enabled.

Pr0.04	Inertia ratio	Range	unit	default	Related control mode		
		0 -10000	%	250	P	S	T

You can set up the ratio of the load inertia against the rotor(of the motor)inertia.

$$\text{Pr0.04} = (\text{load inertia} / \text{rotate inertia}) \times 100\%$$



Notice:

If the inertia ratio is correctly set, the setup unit of Pr1.01 and Pr1.06 becomes (Hz). When the inertia ratio of Pr0.04 is larger than the actual value, the setup unit of the velocity loop gain becomes larger, and when the inertia ratio of Pr0.04 is smaller than the actual value, the setup unit of the velocity loop gain becomes smaller.

Pr0.06*	Command Pulse Rotational Direction Setup	Range	unit	default	Related control mode		
		0 -1	-	0	P		

Set command pulse input rotate direction, command pulse input type

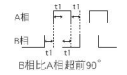
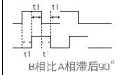
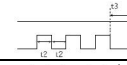
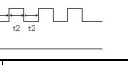
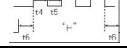
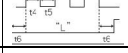
Pr0.07*	Command Pulse Input Mode Setup	Range	unit	default	Related control mode		
		0 -3	-	3	P		

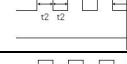
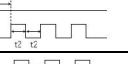
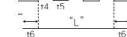
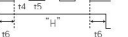
Pr0.06	Pr0.07	Command Pulse Format	Signal	Positive Direction Command	Negative Direction Command
0	0 or 2	90 phase difference 2-phase pulse(A phase +B phase)	Pulse sign		
	1	Positive direction pulse + negative direction pulse	Pulse sign		
	3	Pulse + sign	Pulse sign		
1	0 or 2	90 phase difference 2 phase pulse(A phase +B phase)	Pulse sign		
	1	Positive direction pulse + negative direction pulse	Pulse sign		
	3	Pulse + sign	Pulse sign		

Command pulse input signal allow largest frequency and smallest time width

PULS/SIGN Signal Input I/F		Permissible Max. Input Frequency	Smallest Time Width					
			t1	t2	t3	t4	t5	t6
Pulse series interface	Long distance interface	500kpps	2	1	1	1	1	1
	Open-collector output	200kpps	5	2.5	2.5	2.5	2.5	2.5

Pr0.09	1st numerator of electronic gear	Range	unit	default	Related control mode		
		1-32767	-	1	P		

Set the numerator of division/multiplication operation made according to the command pulse input.

Pr0.10	denominator of electronic gear	Range	unit	default	Related control mode		
		1-32767	-	1	P		

Set the denominator of division/multiplication operation made according to the command pulse input.

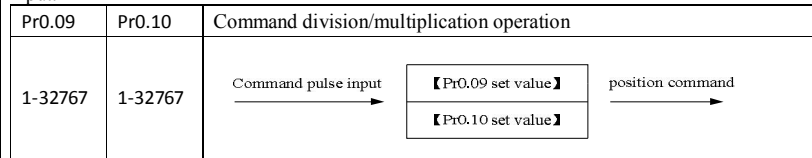

Pr0.11*	Output pulse counts per one motor revolution	Range	unit	default	Related control mode		
		1-2500	P/r	2500	P	S	T

Set the numerator of division/multiplication operation made according to the command pulse input.

Pr5.03*	denominator of pulse output division	Range	unit	default	Related control mode		
		1-2500	-	250 0	P	S	T

Combination of Pr0.11 Output pulse counts per one motor revolution and Pr5.03 Denominator of pulse output division

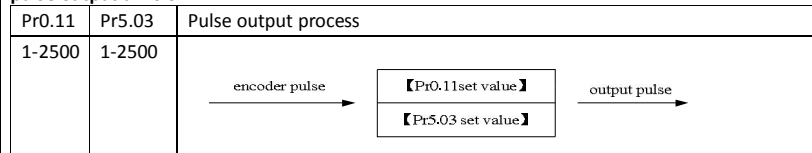

Pulse output resolution after dividing double frequency 4 times



$$\text{Pulse output resolution} = \text{encoder} \times 4 \times \frac{\text{Pr0.11}(\text{pulse output divide frequency molecule})}{\text{Pr5.03}(\text{pulse output divide frequency denominator})}$$

Pr0.12*	reversal of pulse output logic	Range	unit	default	Related control mode		
		0-1	-	0	P	S	T

You can set up the B phase logic and the output source of the pulse output. With this parameter, you can reverse the phase relation between the A-phase pulse and B-phase pulse by reversing the B-phase logic.

< reversal of pulse output logic >

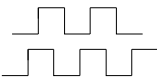
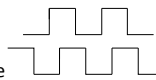
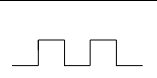
Pr0.12	B-phase Logic	CCW Direction Rotation	CW Direction Rotation
0	Non-Reversal	A phase	A phase

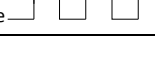
		 B phase	 B phase
1	Reversal	 A phase	 A phase
		 B phase	 B phase

Pr0.13	1st Torque Limit	Range	unit	default	Related control mode		
		0-500	%	300	P	S	T

You can set up the limit value of the motor output torque, as motor rate current %, the value can't exceed the maximum of output current.

Pr0.14	Position Deviation Excess Setup	Range	unit	default	Related control mode		
		0-500	0.1 rev	200	P		

Set excess range of positional deviation by the command unit(default).Setting the value too small will cause Err18.0 (position deviation excess detection)

4.2.2 【Class 1】 Gain Adjust

Pr1.00	1st gain of position loop	Range	unit	default	Related control mode		
		0-30000	0.1/s	320	P		

You can determine the response of the positional control system. Higher the gain of position loop you set, faster the positioning time you can obtain. Note that too high setup may cause oscillation.

Pr1.01	1st gain of velocity loop	Range	unit	default	Related control mode		
		0-32767	0.1Hz	180	P	S	T

You can determine the response of the velocity loop. In order to increase the response of overall servo system by setting high position loop gain, you need higher setup of this velocity loop gain as well. However, too high setup may cause oscillation.

Pr1.02	1st Time Constant of Velocity Loop Integration	Range	unit	default	Related control mode		
		0-10000	0.1ms	310	P	S	T

You can set up the integration time constant of velocity loop, Smaller the set up, faster you can dog-in deviation at stall to 0.The integration will be maintained by setting to "9999". The integration effect will be lost by setting to "10000".

Pr1.03	1st Filter of Velocity Detection	Range	unit	default	Related control mode		
		0-31	-	15	P	S	T

You can set up the time constant of the low pass filter (LPF) after the speed detection, in 32 steps (0 to 31).Higher the setup, larger the time constant you can obtain so that you can decrease the motor noise, however, response becomes slow.
You can set the filter parameters through the loop gain, referring to the following table:

Set Value	Speed Detection Filter Cut-off Frequency(Hz)	Set Value	Speed Detection Filter Cut-off Frequency(Hz)
0	2500	16	750
1	2250	17	700
2	2100	18	650
3	2000	19	600
4	1800	20	550
5	1600	21	500
6	1500	22	450
7	1400	23	400
8	1300	24	350
9	1200	25	300
10	1100	26	250
11	1000	27	200
12	950	28	175
13	900	29	150
14	850	30	125
15	800	31	100

Pr1.04	2nd Time Constant of torque filter	Range	unit	default	Related control mode		
		0 -2500	0.01ms	126	P	S	T
Pr1.05	2nd gain of position loop	Range	unit	default	Related control mode		
		0 -30000	0.1/s	380	P		
Pr1.06	2nd gain of velocity loop	Range	unit	default	Related control mode		
		0 -32767	0.1Hz	180	P	S	T
Pr1.07	2nd Time Constant of Velocity Loop Integration	Range	unit	default	Related control mode		
		0 -10000	0.1ms	10000	P	S	T
Pr1.08	2nd Filter of Velocity Detection	Range	unit	default	Related control mode		
		0 -31	-	15	P	S	T
Pr1.09	2nd Time Constant of torque filter	Range	unit	default	Related control mode		
		0 -2500	0.01ms	126	P	S	T

Position loop, velocity loop, velocity detection filter, torque command filter have their 2 pairs of gain or time constant(1st and 2nd).

Pr1.10	Velocity feed forward gain	Range	unit	default	Related control mode		
		0 -1000	0.1%	300	P		

Multiply the velocity control command calculated according to the internal positional command by the ratio of this parameter and add the result to the speed command resulting from the positional control process.

Pr1.11	Velocity feed forward filter	Range	unit	default	Related control mode		
		0 -6400	0.01ms	50	P		

Set the time constant of 1st delay filter which affects the input of speed feed forward.
(usage example of velocity feed forward)
 The velocity feed forward will become effective as the velocity feed forward gain is gradually increased with the speed feed forward filter set at approx.50 (0.5ms). The positional deviation during

operation at a constant speed is reduced as shown in the equation below in proportion to the value of velocity feed forward gain.
 Position deviation [unit of command]=command speed [unit of command /s]/position loop gain[1/s]×(100-speed feed forward gain[%]/100

Pr1.12	Torque feed forward gain	Range	unit	default	Related control mode	
		0 -1000	0.1%	0	P	S
<ul style="list-style-type: none"> ● Multiply the torque control command calculated according to the velocity control command by the ratio of this parameter and add the result to the torque command resulting from the velocity control process. ● To use torque feed forward, correctly set ratio of inertia. Set the inertia ratio that can be calculated from the machine specification to Pr0.04 inertia ratio. ● Positional deviation at a constant acceleration/deceleration can be minimized close to 0 by increasing the torque forward gain .this means that positional deviation can be maintained at near 0 over entire operation range while driving in trapezoidal speed pattern under ideal condition where disturbance torque is not active. 						

Pr1.13	Torque feed forward filter	Range	unit	default	Related control mode	
		0 -6400	0.01ms	0	P	S
Set up the time constant of 1st delay filter which affects the input of torque feed forward. zero positional deviation is impossible in actual situation because of disturbance torque. as with the velocity feed forward, large torque feed forward filter time constant decreases the operating noise but increases positional deviation at acceleration change point.						

Pr1.15	Mode of position control switching	Range	unit	default	Related control mode	
		0 -10	-	0	P	
Setting value	Switching condition	Gain switching condition				
0	Fixed to 1st gain	Fixed to the 1st gain (Pr1.00-Pr1.04)				
1	Fixed to 2nd gain	Fixed to the 2nd gain (Pr1.05-Pr1.09)				
2	with gain switching input	<ul style="list-style-type: none"> ● 1st gain when the gain switching input is open. ● 2nd gain when the gain switching input is connected to com- . ◇ If no input signal is allocated to the gain switching input, the 1st gain is fixed. 				
3	Torque command is large	<ul style="list-style-type: none"> ● Shift to the 2nd gain when the absolute value of the torque command exceeded (level + hysteresis)[%]previously with the 1st gain. ● Return to the 1st gain when the absolute value of the torque command was kept below (level + hysteresis) [%]previously during delay time with the 2nd gain. 				
4	reserve	reserve				
5	Speed command is large	<ul style="list-style-type: none"> ● Valid for position and speed controls. ● Shift to the 2nd gain when the absolute value of the speed command exceeded (level + hysteresis)[r/min]previously with the 1st gain. ● Return to the 1st gain when the absolute value of the speed command was kept below (level + hysteresis) [r/min] previously during delay time with the 2nd gain. 				
6	Position deviation is large	<ul style="list-style-type: none"> ● Valid for position control. ● Shift to the 2nd gain when the absolute value of the positional deviation exceeded (level + hysteresis)[pulse] previously with the 1st gain. ● Return to the 1st gain when the absolute value of the 				

		positional deviation was kept below (level + hysteresis)[r/min]previously during delay time with the 2nd gain. ✧ Unit of level and hysteresis [pulse] is set as the encoder resolution for positional control.
7	position command exists	<ul style="list-style-type: none"> ● Valid for position control. ● Shift to the 2nd gain when the positional command was not 0 previously with the 1st gain. ● Return to the 1st gain when the positional command was kept 0 previously during delay time with the 2nd gain.
8	Not in positioning complete	<ul style="list-style-type: none"> ● Valid for position control. ● Shift to the 2nd gain when the positioning was not completed previously with the 1st gain. ● Return to the 1st gain when the positioning was kept in completed condition previously during delay time with the 2nd gain.
9	Actual speed is large	<ul style="list-style-type: none"> ● Valid for position control. ● Shift to the 2nd gain when the absolute value of the actual speed exceeded (level + hysteresis) (r/min) previously with the 1st gain. ● Return to the 1st gain when the absolute value of the actual speed was kept below (level - hysteresis) (r/min) previously during delay time with the 2nd gain.
10	Have position command +actual speed	<ul style="list-style-type: none"> ● Valid for position control. ● Shift to the 2nd gain when the positional command was not 0 previously with the 1st gain. ● Return to the 1st gain when the positional command was kept at 0 during the delay time and the absolute value of actual speed was kept below (level - hysteresis) (r/min) previously with the 2nd gain.

In position control mode, setup Pr1.15=3,5,6,9,10;
 In speed control mode, setup Pr1.15=3,5,9;

Pr1.17	Level of position control switching	Range	unit	default	Related control mode	
		0-20000	Mode dependent	50	P	

Unit of setting varies with switching mode.
 switching condition: position :encoder pulse number ; speed : r/min ; torque : % .
Notice set the level equal to or higher than the hysteresis.

Pr1.18	Hysteresis at position control switching	Range	unit	default	Related control mode	
		0-20000	Mode dependent	33	P	

Combining Pr1.17(control switching level)setup
Notice when level< hysteresis, the hysteresis is internally adjusted so that it is equal to level.

Pr1.19	position gain switching time	Range	unit	default	Related control mode	
		0-10000	0.1ms	33	P	

For position controlling: if the difference between 1st gain and 2nd gain is large, the increasing rate of position loop gain can be limited by this parameter.
<Position gain switching time>

Notice: when using position control, position loop gain rapidly changes, causing torque change and vibration. By adjusting Pr1.19 position gain switching time, increasing rate of the position loop gain can be decreased and variation level can be reduced.

Example: 1st (Pr1.00) <-> 2nd (Pr1.05)

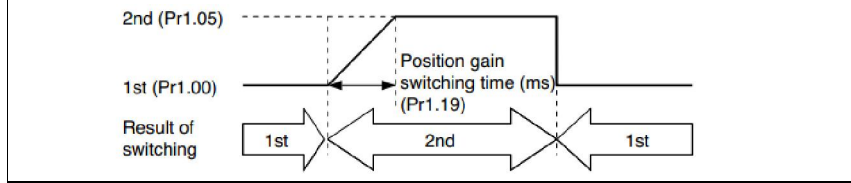

Pr1.35*	positional command filter setup	Range	unit	default	Related control mode		
		0 -200	0.05us	0	P		
Do filtering for positional command pulse, eliminate the interference of the narrow pulse, over-large setup will influence the input of high frequency positional command pulse, and make more time-delayed.							
Pr1.36*	pulse digital filter of encoder feedback setup	Range	unit	default	Related control mode		
		0 -10000	0.1ms	33	P		
Do filtering for pulse of encoder feedback, eliminate the interference of the narrow pulse, over-large setup will influence the performance of motor in large speed, and influence the control performance of motor causing by large time-delayed.							

4.2.3 【Class 2】 Vibration Suppression

Pr2.01	1st notch frequency	Range	unit	default	Related control mode		
		50 -2000	HZ	2000	P	S	T
Set the center frequency of the 1st notch filter							
Notice: the notch filter function will be invalidated by setting up this parameter to “2000”.							
Pr2.02	1st notch width selection	Range	unit	default	Related control mode		
		0 -20	-	2	P	S	T
Set the width of notch at the center frequency of the 1st notch filter.							
Notice: Higher the setup, larger the notch width you can obtain. Use with default setup in normal operation.							
Pr2.03	1st notch depth selection	Range	unit	default	Related control mode		
		0 -99	-	0	P	S	T
Set the depth of notch at the center frequency of the 1st notch filter.							
Notice: Higher the setup, shallower the notch depth and smaller the phase delay you can obtain.							
Pr2.04	2nd notch frequency	Range	unit	default	Related control mode		
		50 -2000	HZ	2000	P	S	T
Set the center frequency of the 2nd notch filter							
Notice: the notch filter function will be invalidated by setting up this parameter to “2000”.							
Pr2.05	2nd notch width selection	Range	unit	default	Related control mode		
		0 -20	-	2	P	S	T

Set the width of notch at the center frequency of the 2nd notch filter.

Notice Higher the setup, larger the notch width you can obtain. Use with default setup in normal operation.

Pr2.06	2nd notch depth selection	Range	unit	default	Related control mode		
		0-99	-	0	P	S	T

Set the depth of notch at the center frequency of the 2nd notch filter.

Notice Higher the setup, shallower the notch depth and smaller the phase delay you can obtain.

Pr2.22	positional command smoothing filter	Range	unit	default	Related control mode		
		0-32767	0.1ms	0	P		

- Set up the time constant of the 1st delay filter in response to the positional command.
- When a square wave command for the target speed V_c is applied, set up the time constant of the 1st delay filter as shown in the figure below.

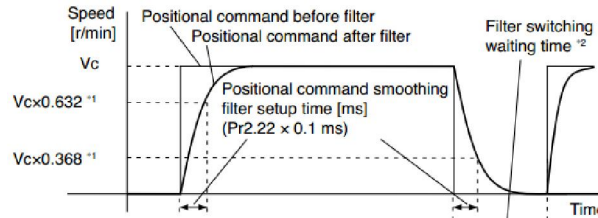

Pr2.23	positional command FIR filter	Range	unit	default	Related control mode		
		0-10000	0.1ms	0	P		

- Set up the time constant of the 1st delay filter in response to the positional command.
- When a square wave command for the target speed V_c is applied, set up the V_c arrival time as shown in the figure below.

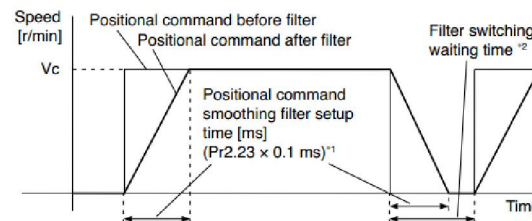

Note: For parameters which No. have a suffix of "*", changed contents will be validated when you turn on the control power.

4.2.4 【Class 3】 Velocity/ Torque Control

Pr3.00	Speed setup, Internal /External switching	Range	unit	default	Related control mode		
		0-3	-	0		S	

This driver is equipped with internal speed setup function so that you can control the speed with contact inputs only.

Setup value	Speed setup method
0	Analog speed command(SCR)
1	Internal speed command 1st to 4th speed(PR3.04-PR3.07)
2	Internal speed command 1st to 3rd speed (PR3.04-PR3.06), Analog speed command(SCR)
3	Internal speed command 1st to 8th speed (PR3.04-PR3.11)

<relationship between Pr3.00 Internal/External switching speed setup and the internal command speed selection 1-3 and speed command to be selected>

Setup value	selection 1 of internal command speed(INTSPD1)	selection 2 of internal command speed (INTSPD2)	selection 3 of internal command speed (INTSPD3)	selection of Speed command
1	OFF	OFF	NO effect	1st speed
	ON	OFF		2nd speed
	OFF	ON		3rd speed
	ON	ON		4th speed
2	OFF	OFF	NO effect	1st speed
	ON	OFF		2nd speed
	OFF	ON		3rd speed
	ON	ON		Analog speed command
3	The same as [Pr3.00=1]		OFF	1st to 4th speed
	OFF	OFF	ON	5th speed
	ON	OFF	ON	6th speed
	OFF	ON	ON	7th speed

Pr3.01	Speed command rotational direction selection	Range	unit	default	Related control mode	
		0 -1	-	0	S	T

Select the Positive /Negative direction specifying method

Setup value	Select speed command sign (1st to 8th speed)	Speed command direction (VC-SIGN)	Position command direction
0	+	No effect	Positive direction
	-	No effect	Negative direction
1	Sign has no effect	OFF	Positive direction
	Sign has no effect	ON	Negative direction

Pr3.02	Input gain of speed command	Range	unit	default	Related control mode	
		10 -2000	(r/min)/v	500	S	T

Based on the voltage applied to the analog speed command (SCR), set up the conversion gain to motor command speed.

You can set between the voltage and Pr3.02.

hence input 3000r/min.

Notice:

1. Do not $\pm 10V$ to the input(SCR).
2. When

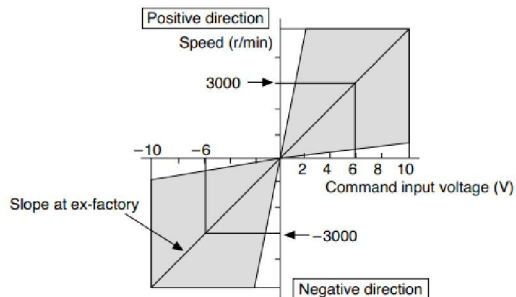

up "slope" of relation command input motor speed, with Default is set to Pr3.02=500(r/min)/V, of 6V becomes

apply more than speed command

you compose a

position loop outside of the driver while you use the driver in velocity control mode, the setup of Pr3.02 gives larger variance to the overall servo system.
 3. Pay an extra attention to oscillation caused by larger setup of Pr3.02.

Pr3.03	Reversal of speed command input	Range	unit	default	Related control mode
		0 -1	-	500	S

Specify the polarity of the voltage applied to the analog speed command (SPR).

Setup value	Motor rotating direction	
0	Non-reversal	[+ voltage] → [+ direction] [- voltage] → [-direction]
1	reversal	[+ voltage] → [- direction] [- voltage] → [+direction]

Caution: When you compose the servo drive system with this driver set to velocity control mode and external positioning unit, the motor might perform an abnormal action if the polarity of the speed command signal from the unit and the polarity of this parameter setup does not match.

Pr3.04	1st speed of speed setup	Range	unit	default	Related control mode
		-20000 -20000	r/min	0	S
Pr3.05	2nd speed of speed setup	Range	unit	default	Related control mode
		-20000 -20000	r/min	0	S
Pr3.06	3rd speed of speed setup	Range	unit	default	Related control mode
		-20000 -20000	r/min	0	S
Pr3.07	4th speed of speed setup	Range	unit	default	Related control mode
		-20000 -20000	r/min	0	S
Pr3.08	5th speed of speed setup	Range	unit	default	Related control mode
		-20000 -20000	r/min	0	S
Pr3.09	6th speed of speed setup	Range	unit	default	Related control mode
		-20000 -20000	r/min	0	S
Pr3.10	7th speed of speed setup	Range	unit	default	Related control mode
		-20000 -20000	r/min	0	S
Pr3.11	8th speed of speed setup	Range	unit	default	Related control mode
		-20000 -20000	r/min	0	S

Set up internal command speeds, 1st to 8th

Pr3.12	Acceleration time setup	Range	unit	default	Related control mode
		0 -10000	Ms(1000r/min)	100	S
Pr3.13	Deceleration time setup	Range	unit	default	Related control mode
		0 -10000	Ms(1000r/min)	100	S

Set up acceleration/deceleration processing time in response to the speed command input.

Set the time required for the speed command(stepwise input)to reach 1000r/min to Pr3.12 Acceleration time setup. Also set the time required for the speed command to reach from 1000r/min to 0 r/min, to Pr3.13 Deceleration time setup.

Assuming that the target value of the speed command is V_c (r/min), the time required for acceleration/deceleration can be computed from the formula shown below.

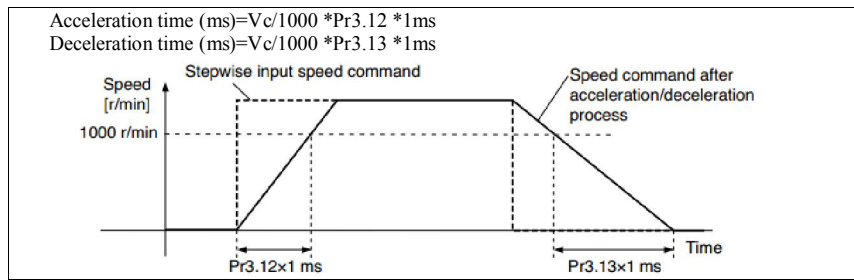

Pr3.14	Sigmoid acceleration/deceleration time setup	Range	unit	default	Related control mode	
		0 - 1000	ms	0	S	

Set S-curve time for acceleration/deceleration process when the speed command is applied.

According to Pr3.12 Acceleration time setup and Pr3.13 Deceleration time setup, set up sigmoid time with time width centering the inflection point of acceleration/deceleration.

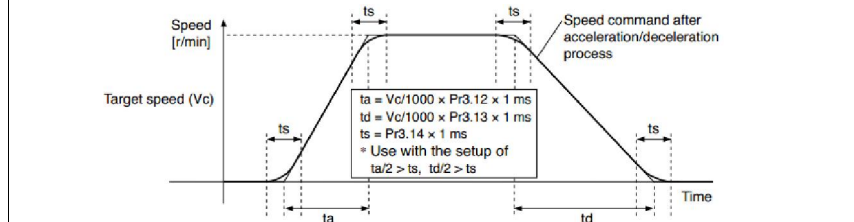

Pr3.15	Speed zero-clamp function selection	Range	unit	default	Related control mode	
		0 - 3	-	0	S	T

- If Pr3.15=0, the function of zero clamp is forbidden. It means the motor rotates with actual velocity which is controlled by the analog voltage input 1 even if the velocity is less than 10 rpm. The motor runs no matter what the value of Pr3.16 is. The actual velocity is controlled by external the analog voltage input.
- If Pr3.15=1 and the input signal of Zero Speed is available in the same time, the function of zero clamp works. It means motor will stop rotating in servo-on condition no matter what the velocity of motor is, and motor stop rotating no matter what the value of Pr3.16 is.
- If Pr3.15=2, the function of zero clamp belongs to the value of Pr3.16. If the actual velocity is less than the value of Pr3.16, the motor will stop rotating in servo-on condition.

Pr3.16	Speed zero-clamp level	Range	unit	default	Related control mode	
		0 - 20000	r/min	30	S	T

When analog speed given value under speed control mode less than zero speed clamp level setup, speed command will set to 0 strongly.

Pr3.18	Torque command direction selection	Range	unit	default	Related control mode	
		0 - 1	-	0		T

Select the direction positive/negative direction of torque command

Setup value	designation
0	Specify the direction with the sign of torque command Torque command input[+] → positive direction, [-] → negative direction
1	Specify the direction with torque command sign(TC-SIGN). OFF: positive direction ON: negative direction

Pr3.19	Torque command input gain	Range	unit	default	Related control mode		
		0 -1	-	500			T

Based on the voltage (V) applied to the analog torque command (TRQR), set up the conversion gain to torque command(%).

- Unit of the setup value is [0.1V/100%] and set up input voltage necessary to produce the rated torque.
- Default setup of 30 represents 3V/100%

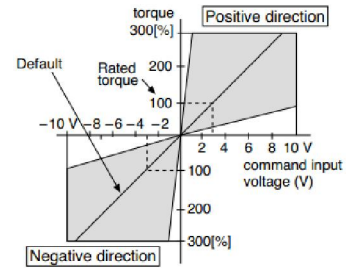

Pr3.20	Torque command input reversal	Range	unit	default	Related control mode		
		0 -1	-	0			T

Set up the polarity of the voltage applied to the analog torque command(TRQR).

Setup value	Direction of motor output torque	
0	Non-reversal	[+ voltage] → [+ direction] [- voltage] → [-direction]
1	reversal	[+ voltage] → [- direction] [- voltage] → [+direction]

Pr3.21	Speed limit value 1	Range	unit	default	Related control mode		
		0 -20000	r/min	0			T

Set up the speed limit used for torque controlling.

During the torque controlling, the speed set by the speed limit value cannot be exceeded.

Pr3.24*	Motor rotate maximum speed limit	Range	unit	default	Related control mode		
		0 -6000	r/min	3000	P	S	T

Set up motor running max rotate speed, but can't be exceeded motor allowed max rotate speed.

Note: For parameters which No. have a suffix of "**", changed contents will be validated when you turn on the control power.

4.2.5 【Class 4】 I/F Monitor Setting

Pr4.00*	SI1 input selection	Range	unit	default	Related control mode		
		0-00FFFFFFh	-	00030303h	P	S	T
Pr4.01*	SI2 input selection	Range	unit	default	Related control mode		
		0-00FFFFFFh	-	00828282h	P	S	T
Pr4.02*	SI3 input selection	Range	unit	default	Related control mode		
		0-00FFFFFFh	-	00818181h	P	S	T
Pr4.03*	SI4 input selection	Range	unit	default	Related control mode		
		0-00FFFFFFh	-	00919191h	P	S	T
Pr4.04*	SI5 input selection	Range	unit	default	Related control mode		
		0-00FFFFFFh	-	00000007h	P	S	T

S Set SI1 input function allocation.

This parameter use 16 binary system to set up the values, as following :

00- - - * * h: position control

00- - * * - - h: velocity control

00* * - - - h: torque control

Please at [**] partition set up function number

For the function number, please refer to the following Figure.

Signal name	symbol	Set value	
		a-contact	b- contact
Invalid	-	00h	Do not setup
Positive direction over-travel inhibition input	POT	01h	81h
negative direction over-travel inhibition input	NOT	02h	82h
Servo-ON input	SRV-ON	03h	83h
Alarm clear input	A-CLR	04h	Do not setup
Control mode switching input	C-MODE	05h	85h
Gain switching input	GAIN	06h	86h
Deviation counter clear input	CL	07h	Do not setup
Command pulse inhibition input	INH	08h	88h
Electronic gear switching input 1	DIV1	0Ch	8Ch
Electronic gear switching input 2	DIV2	0Dh	8Dh
Selection 1 input of internal command speed	INTSPD1	0Eh	8Eh
Selection 2 input of internal command speed	INTSPD2	0Fh	8Fh
Selection 3 input of internal command speed	INTSPD3	10h	90h
Speed zero clamp input	ZEROSPD	11h	91h
Speed command sign input	VC-SIGN	12h	92h
Torque command sign input	TC-SIGN	13h	93h
Forced alarm input	E-STOP	14h	94h

Note:

1. a-contact means input signal comes from external controller or component ,for example: PLC .
2. b-contact means input signal comes from driver internally.
3. Don't setup to a value other than that specified in the table .
4. Don't assign specific function to 2 or more signals. Duplicated assignment will cause Err21.0 I/F input multiple assignment error 1or Err21.1 I/F input multiple assignment error 2.

Pr4.10*	S01 output selection	Range	unit	default	Related control mode		
		0-00FFFFFFh	-	00010101h	P	S	T
Pr4.11*	S02 output selection	Range	unit		Related control mode		
		0-00FFFFFFh	-	00020202h (131586)	P	S	T
Pr4.12*	S03 output selection	Range	unit		Related control mode		
		0-00FFFFFFh	-	00000704h (65793)	P	S	T
Pr4.13*	S04 output selection	Range	unit		Related control mode		
		0-00FFFFFFh	-	00000303h (328964)	P	S	T

Assign functions to S01 outputs.

This parameter use 16 binary system do setup, as following :

00- - - * * h: position control

00- - * * - - h: velocity control

00* * - - - h: torque control

Please at [**] partition set up function number.

For the function number, please refer to the following Figure.

Signal name	symbol	Setup value
Invalid	-	00h
Alarm output	Alm	01h
Servo-Ready output	S-RDY	02h
Eternal brake release signal	BRK-OFF	03h
Positioning complete output	INP	04h
At-speed output	AT-SPPED	05h
Zero-speed detection output	ZSP	07h
Velocity coincidence output	V-COIN	08h
Positional command ON/OFF output	P-CMD	0Bh
Speed command ON/OFF output	V-CMD	0Fh

Pr4.22	Analog input 1 (AI1) offset setup	Range	unit	default	Related control mode		
		-5578 -5578	-	0		S	

Set up the offset correction value applied to the voltage fed to the analog input 1.

Pr4.23	Analog input 1 (AI1) filter	Range	unit	default	Related control mode		
		0-6400	0.01ms	0		S	

Set up the time constant of 1st delay filter that determines the lag time behind the voltage applied to the analog input 1.

Pr4.28	Analog input 3 (AI3) offset setup	Range	unit	default	Related control mode		
		0 -1	-	500			T

Set up the offset correction value applied to the voltage fed to the analog input 3.

Pr4.29	Analog input 3 (AI3) filter	Range	unit	default	Related control mode		
		0 -1	-	500			T

Set up the time constant of 1st delay filter that determines the lag time behind the voltage applied to the analog input 3.

Pr4.31	Positioning complete range	Range	unit	default	Related control mode		
		0 -10000	Encoder unit	10	P		

Set up the timing of positional deviation at which the positioning complete signal (INP1) is output.

Pr4.32	Positioning complete range	Range	unit	default	Related control mode		
		0 -3	command unit	10	P		

Select the condition to output the positioning complete signal (INP1).

Setup value	Action of positioning complete signal
0	The signal will turn on when the positional deviation is smaller than Pr4.31 [positioning complete range].
1	The signal will turn on when there is no position command and position deviation is smaller than Pr4.31 [positioning complete range].
2	The signal will turn on when there is no position command, the zero-speed detection signal is ON and the positional deviation is smaller than Pr4.31 [positioning complete range].
3	The signal will turn on when there is no position command and the positional deviation is smaller than Pr4.31 [positioning complete range]. Then holds "ON" states until the next position command is entered. Subsequently, ON state is maintained until Pr4.33 INP hold time has elapsed. After the hold time, INP output will be turned ON/OFF according to the coming positional command or condition of the positional deviation.

Pr4.33	INP hold time	Range	unit	default	Related control mode		
		0-30000	1ms	0	P		

Set up the hold time when Pr 4.32 positioning complete output setup=3.

Setup value	State of Positioning complete signal
0	The hold time is maintained definitely, keeping ON state until next positional command is received.
1-30000	ON state is maintained for setup time (ms)but switched to OFF state as the positional command is received during hold time.

Pr4.34	Zero-speed	Range	unit	default	Related control mode		
		10 -20000	r/min	50	P	S	T

You can set up the timing to feed out the zero-speed detection output signal(ZSP or TCL) in rotate speed (r/min).
The zero-speed detection signal(ZSP) will be fed out when the motor speed falls below the setup of this parameter, Pr4.34

- the setup of pr4.34 is valid for both positive and negative direction regardless of the motor rotating direction.
- There is hysteresis of 10[r/min].

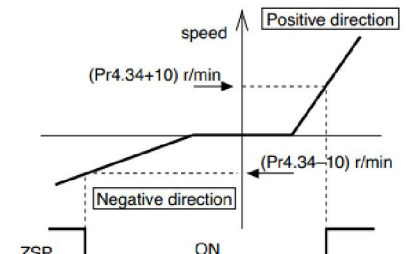

Pr4.35	Speed coincidence range	Range	unit	default	Related control mode
		10 -20000	r/min	50	S

Set the speed coincidence (V-COIN) output detection timing.
Output the speed coincidence (V-COIN) when the difference between the speed command and the motor speed is equal to or smaller than the speed specified by this parameter.

Because the speed coincidence detection is associated with 10 r/min hysteresis, actual detection range is as shown below.

Speed coincidence output OFF -> ON timing (Pr4.35 -10) r/min
Speed coincidence output ON -> OFF timing (Pr4.35 +10) r/min

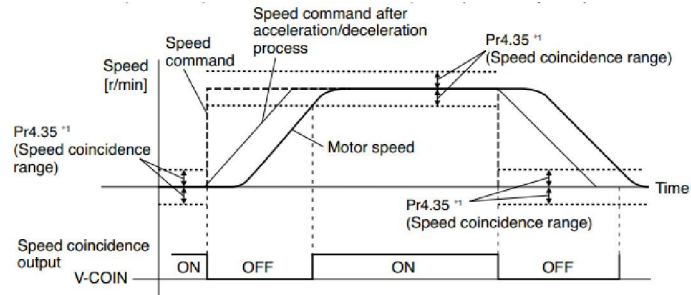

Pr4.36	At-speed(Speed arrival)	Range	unit	default	Related control mode
		10-20000	r/min	1000	S

Set the detection timing of the speed arrival output (AT-SPEED).
When the motor speed exceeds this setup value, the speed arrive output (AT-SPEED) is output.
Detection is associated with 10r/min hysteresis .

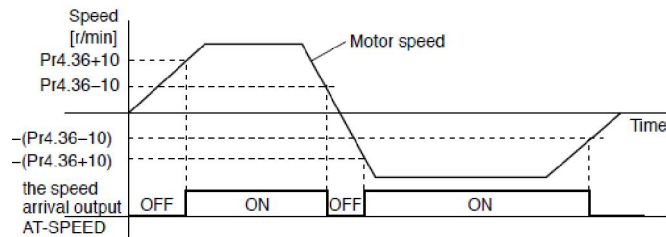

Pr4.37	Mechanical brake action at stalling setup	Range	unit	default	Related control mode
		0 -10000	1ms	0	P S T

Motor brake delay time setup, mainly used to prevent servo on “galloping” phenomenon. Set up the time from when the brake release signal(BRK-OFF) turns off to when the motor is de-energized (servo-free),when the motor turns to servo-off while the motor is at stall

- Set up to prevent a micro-travel/drop of the motor (work) due to the action delay time(tb) of the brake.
- After setting up Pr4.37>=tb, then compose the sequence so as the driver turns to servo-off after the brake is actually activated.

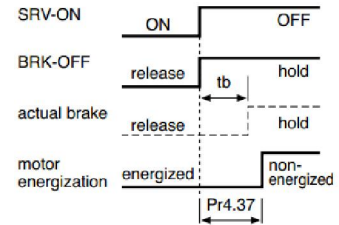

Pr4.38	Mechanical brake action at running setup	Range	unit	default	Related control mode		
		0 -10000	1ms	0	P	S	T

Mechanical brake start delay time setup, mainly used to prevent servo off “galloping” phenomenon. Set up time from when detecting the off of servo-on input signal(SRV-ON)is to when external brake release signal(BRK-OFF)turns off, while the motor turns to servo off during the motor in motion.

- Set up to prevent the brake deterioration due to the motor running.
- At servo-OFF during the motor is running , tb of the right fig will be a shorter one of either Pr4.38 setup time, or time lapse till the motor speed falls below Pr4.39 setup speed.

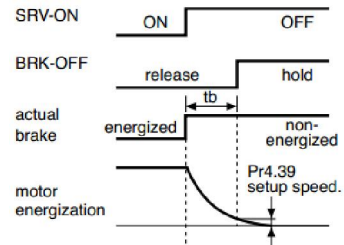

Pr4.39	Brake release speed setup	Range	unit	default	Related control mode		
		30 -3000	1ms	30	P	S	T

When servo off, rotate speed less than this setup vale, and mechanical brake start delay time arrive, motor lost power.

4.2.6 【Class 5】 Extended Setup

Pr5.00	2nd numerator of electronic gear	Range	unit	default	Related control mode		
		1-32767	-	1	P	S	T
Pr5.01	3rd numerator of electronic gear	Range	unit	default	Related control mode		
		1-32767	-	1	P	S	T
Pr5.02	4th numerator of electronic gear	Range	unit	default	Related control mode		
		1-32767	-	1	P	S	T
Pr5.03*	Denominator of pulse output division	Range	unit	default	Related control mode		
		1-2500	-	2500	P	S	T

According to the command pulse input , set the 2nd to 4th numerator of electronic gear

DIV1	DIV2	numerator of electronic gear	denominator of electronic gear
OFF	OFF	Pr0.09	Pr5.03
ON	OFF	Pr5.00	Pr5.03
OFF	ON	Pr5.01	Pr5.03
ON	ON	Pr5.02	Pr5.03

For details, refer to Pr0.11 .

Pr5.06	Sequence at servo-off	Range	unit	default	Related control mode		
		0-1	-	0	P	S	T
Specify the status during deceleration and after stop, after servo-off.							
Setup value	during deceleration	After stop					
0	emergency	Free-run					
1	Free-run	Free-run					

Pr5.08	LV trip selection at main power OFF	Range	unit	default	Related control mode		
		0-1	-	0	P	S	T
You can select whether or not to activate Err0d.0 (main power under-voltage protection)function while the main shutoff continues for the setup of Pr5.09(The main power-OFF detection time).							
Setup value	Action of main power low voltage protection						
0	When the main power is shut off during Servo-On,Err0d.0 will not be triggered and the driver turns to Servo-OFF. The driver returns to Servo-On again after the main power resumption.						
1	When the main power is shut off during Servo-On, the driver will trip due to Err0d.0						
Caution: Err0d.0(main power under-voltage protection) is trigged when setup of Pr5.09 is long and P-N voltage of the main converter falls below the specified value before detecting the main power shutoff , regardless of the Pr5.08 setup.							

Pr5.09*	The main power-OFF detection time	Range	unit	default	Related control mode		
		70-2000	1ms	70	P	S	T
You can set up the time to detect the shutoff while the main power is kept shut off continuously. The main power off detection is invalid when you set up this to 2000.							

Pr5.13	Over-speed level setup	Range	unit	default	Related control mode		
		0-20000	r/min	0	P	S	T
If the motor speed exceeds this setup value, Err1A.0 [over-speed protect] occurs. The over-speed level becomes 1.2 times of the motor max, speed by setting up this to 0.							

Pr5.15*	I/F reading filter	Range	unit	default	Related control mode		
		0-255	0.1ms	0	P	S	T
I/O input digital filtering; higher setup will arise control delay.							

Pr5.28*	LED initial status		Range	unit	default	Related control mode		
			0-35	-	1	P	S	T

You can select the type of data to be displayed on the front panel LED (7-segment) at the initial status after power-on.

Setup value	content	Setup value	content	Setup value	content
0	Positional command deviation	10	I/O signal status	27	Voltage across PN [V]
1	Motor speed	11	Analog input value	28	Software version
2	Positional command speed	12	Error factor and reference of history	29	Driver serial number
3	Velocity control command	16	Inertia ratio	30	Motor serial number
4	Torque command	17	Factor of no-motor running	31	Accumulated operation time
5	Feedback pulse sum	23	Communication axis address	33	Temperature information
6	Command pulse sum	24	Encoder positional deviation[encoder unit]	36	Safety condition monitor
9	Control mode				

Pr5.29*	baud rate setup of RS232 communication		Range	unit	default	Related control mode		
			0-6	-	5	P	S	T

You can set up the communication speed of RS232.

Pr5.30*	baud rate setup of RS485 communication		Range	unit	default	Related control mode		
			0-6	-	2	P	S	T

You can set up the communication speed of RS485.

Set value	Baud rate	Set value	Baud rate
0	2400bps	4	38400bps
1	4800bps	5	57600bps
2	9600bps	6	115200bps
3	19200bps		

Baud rate error is 2400-38400bps±5% ,57600-115200bps±2%

Pr5.31*	Axis address		Range	unit	default	Related control mode		
			0-127	-	1	P	S	T

During communication with the host (e.g. PC) to control multiple shafts, the shaft being accessed by the host should be identified.

Notice: when using RS232/RS485, the maximum valid value is 31.

Pr5.35*	Front panel lock setup		Range	unit	default	Related control mode		
			0-1	-	0	P	S	T

Lock the operation on the front panel.

Setup value	content

0	No limit on the front panel operation	
1	Lock the operation on the front panel	

4.2.7 【Class 6】 Special Setup

Pr6.03	JOG trial run command torque	Range	unit	default	Related control mode		
		0 -100	%	0			T

You can set up the command speed used for JOG trial run (torque control).

Pr6.04	JOG trial run command speed	Range	unit	default	Related control mode		
		0-500	r/min	300	P	S	T

You can set up the command speed used for JOG trial run (velocity control).

Pr6.07	JOG trial run command speed	Range	unit	default	Related control mode		
		-100-100	%	0	P	S	T
Pr6.08	JOG trial run command speed	Range	unit	default	Related control mode		
		-100-100	%	0	P	S	T
Pr6.09	JOG trial run command speed	Range	unit	default	Related control mode		
		-100-100	%	0	P	S	T

This three parameters may apply feed forward torque superposition directly to torque command.

Pr6.20	Trial run distance	Range	unit	default	Related control mode		
		0-200	0.1rev	10	P		

The distance of running each time in JOG run(position control)

Pr6.21	Trial run waiting time	Range	unit	default	Related control mode		
		0-30000	Ms	1000	P		

The waiting time after running each time in JOG run(position control)

Pr6.22	Trial run cycle times	Range	unit	default	Related control mode		
		0-32767	-	10	P		

The cycling times of JOG run(position control)

Chapter 5 Alarm and Processing

5.1 Alarm List

Protection function is activated when an error occurs, the driver will stop the rotation of servo motor, and the front panel will automatically display the corresponding fault error code. The history of the error can be viewed on data monitoring mode. error logging submenu displays like: “”.

The error code displays like:

Er---

Figure 5-1 Panel Alarm Display

Table 5.1 Error Code List

Error code		content	Attribute		
Main	Sub		history	Immediate stop	Can be cleared
		FPGA communication error	•		
		Current detection circuit error	•		
		Analog input circuit error	•		
		DC bus circuit error	•		
		Temperature detection circuit error	•		
		Control power under-voltage	•		
		DC bus over-voltage	•		•
		DC bus under-voltage	•		•
		Over-current	•		
		over -current of intelligent power module(IPM)	•		
		Driver over-heat	•	•	
		Motor over-load	•		•
		Resistor discharged circuit overload	•	•	
		Encoder wiring error	•		
		Encoder initial position error	•		
		Encoder data error	•	•	
		Too large position pulse deviation	•	•	•
		Too large velocity deviation	•	•	•
		Over-speed 1	•	•	•
		I/F input interface allocation error	•		•
		I/F input interface function set error	•		•

	2	I/F output interface function set error	•		•
24	0	CRC verification error when EEPROM parameter saved			
26	0	Positive/negative over-range input valid	•	•	•
58	0	Compulsory alarm input valid	•	•	

Save: save this error history record

Emergency: error, driver will stop immediately

May remove: may through SI input/panel/software ACH Series remove alarm

5.2 Alarm Processing Method

When appear error, please clear error reason, renew power on

Error code	Main	Extra	Display: "E2E090"..."E2E09E"
	09	0~F	Content: FPGA communication error
Cause		confirmation	solution
r,t terminal under-voltage		Check r,t terminal voltage	Make sure voltage of r,t terminal in proper range
Driver internal fault		/	replace the driver with a new one

Error code	Main	Extra	Display: "E2E0A0"..."E2E0AE"
	0A	0~E	Content: current detection circuit error
Cause		confirmation	solution
Wiring error of motor output U,V,W terminal		Check wiring of motor output U,V,W terminal	Make sure motor U,V,W terminal wiring correctly
Main voltage R,S,T terminal voltage whether over-low		Check main voltage R,S,T terminal voltage	Make sure voltage of R,S,T terminal in proper range
Driver inner fault		/	replace the driver with a new one

Error code	Main	Extra	Display: "E2E0A2"..."E2E0AE"
	0A	2~4	Content: analog input circuit error
Cause		confirmation	solution
Analog input Wiring error		Check wiring of analog input	Make sure analog input wiring correctly
Driver inner fault		/	replace the driver with a new one

Error code	Main	Extra	Display: "E2E0A5"
	0A	5	Content: DC bus circuit error
Cause		confirmation	solution
Main voltage R,S,T terminal under-voltage		Check R,S,T terminal voltage	Make sure voltage of R,S,T terminal in proper range

Driver inner fault	/	replace the driver with a new one
--------------------	---	-----------------------------------

Error code	Main	Extra	Display: "E2E0A6"
	E2	A6	
Cause		confirmation	solution
r,t terminal under-voltage		Check r,t terminal voltage	Make sure voltage of r,t terminal in proper range
Driver inner fault		/	replace the driver with a new one

Error code	Main	Extra	Display: "E2E0B0"
	E2	B0	
Cause		confirmation	solution
r,t terminal under-voltage		Check r,t terminal voltage	Make sure voltage of r,t terminal in proper range
Driver inner fault		/	replace the driver with a new one

Error code	Main	Extr	Display: "E2E0E0"
	E2	E0	
Cause		confirmation	solution
Main power R,S,T terminal over-voltage		Check R,S,T terminal voltage	decrease R,S,T terminal Voltage
Inner brake circuit damaged		/	replace the driver with a new one
Driver inner fault		/	replace the driver with a new one

Error code	Main	Extra	Display: "E2E0D0"
	E2	D0	
Cause		confirmation	solution
Main power R,S,T terminal under-voltage		Check R,S,T terminal voltage	increase R,S, T terminal Voltage
Driver inner fault		/	replace the driver with a new one

Error code	Main	Extra	Display: "E2E0E0"
	E2	E0	
Cause		confirmation	solution
Short of driver output wire		Short of driver output wire, whether short circuit to PG ground or not	Assure driver output wire no short circuit, assure motor no damage
Abnormal wiring of motor		Check motor wiring order	Adjust motor wiring sequence
Short of IGBT module		Cut off driver output wiring, make srv on available and drive motor, check whether over-current exists	replace the driver with a new one
abnormal setting of control parameter		Modify the parameter	Adjust parameter to proper range
abnormal setting of control command		Check control command whether command changes too violently or not	Adjust control command: open filter function

Error code	Main	Extra	Display: "E280E8"
		E2	E8
Cause	confirmation		solution
Short of driver output wire	Short of driver output wire, whether short circuit to PG ground or not		Assure driver output wire no short circuit, assure motor no damage
Abnormal wiring of motor	Check motor wiring order		Adjust motor wiring sequence
Short of IGBT module	Cut off driver output wiring, make srv_on available and drive motor, check whether over-current exists or not		replace the driver with a new one
Short of IGBT module	/		replace the driver with a new one
abnormal setting of control parameter	Modify the parameter		Adjust parameter to proper range
abnormal setting of control command	Check control command whether command changes too violently or not		Adjust control command: open filter function

Error code	Main	Extra	Display: "E280E0"
		E2	E0
Cause	confirmation		solution
the temperature of power module have exceeded upper limit	Check driver radiator whether the temperature is too high or not		Strengthen cooling conditions, promote the capacity of driver and motor, enlarge acceleration/deceleration time, reduce load

Error code	Main	Extr	Display: "E280E0"
		E2	E0
Cause	confirmation		solution
Load is too heavy	Check actual load if the value of parameter exceed maximum or not		Decrease load, adjust limit parameter
Oscillation of machine	Check the machine if oscillation exists or not		Modify the parameter of control loop; enlarge acceleration/deceleration time
wiring error of motor	Check wiring if error occurs or not, if line breaks or not		Adjust wiring or replace encoder/motor for a new one
electromagnetic brake engaged	Check brake terminal voltage		Cut off brake

Error code	Main	Extra	Display: "E280E0"
		E2	E0
Cause	confirmation		solution
Regenerative energy has exceeded the capacity of regenerative resistor .	Check the speed if it is too high. Check the load if it is too large or not.		lower motor rotational speed; decrease load inertia ,increase external regenerative resistor, improve the capacity of the driver and motor
Resistance discharge circuit damage	/		Increase external regenerative resistor, replace the driver with a new one

Error code	Main	Extra	Display: "E200150"
		15	0
Cause		confirmation	solution
Encoder line disconnected		check wiring if it steady or not	Make encoder wiring steady
Encoder wiring error		Check encoder wiring if it is correct or not	Reconnect encoder wiring
Encoder damaged		/	replace the motor with a new one
Encoder measuring circuit damaged		/	replace the driver with a new one

Error code	Main	Extr	Display: "E200152"
		15	2
Cause		confirmation	solution
Communication data abnormal		Check encoder power voltage if it is DC5V \pm 5% or not; check encoder cable and shielded line if it is damaged or not; check encoder cable whether it is intertwined with other power wire or not	Ensure power voltage of encoder normally, ensure encoder cable and shielded line well with FG ground, ensure encoder cable separated with other power wire
Encoder damaged		/	replace the motor with a new one
Encoder measuring circuit damaged		/	replace the driver with a new one

Error code	Main	Extra	Display: "E200170"
		17	0
Cause		confirmation	solution
Communication data abnormal		Check encoder power voltage if it is DC5V \pm 5% or not ; check encoder cable and shielded line if it is damaged or not; check encoder cable whether it is intertwined with other power wire or not	Ensure power voltage of encoder normally, ensure encoder cable and shielded line well with FG ground, ensure encoder cable separated with other power wire
Encoder damaged		/	replace the motor with a new one
Encoder measuring circuit damaged		/	replace the driver with a new one

Error code	Main	Extra	Display: "E200180"
		18	0
Cause		confirmation	solution
Unreasonable set of position error parameter		Check parameter PA_014 value if it is too small or not	Enlarge the value of PA_014
Gain set is too small		Check parameter PA_100, PA_105 value if it is too small or not	Enlarge the value of PA_100, PA_105
Torque limit is too small		Check parameter PA_013, PA_522 value whether too small or not	Enlarge the value of PA_103, PA_522
Outside load is too large		Check acceleration/ deceleration time if it is too small or not , check motor rotational speed if it is too big or not ; check load if	Increase acceleration/ deceleration time decrease speed, decrease load

	it is too large or not	
--	------------------------	--

Error code	Main	Extra	Display: "E28888"
	18	8	Content: velocity error over-large error
Cause		confirmation	solution
The deviation of inner position command velocity is too large with actual speed		Check the value of PA_602 if it is too small or not	Enlarge the value of PA_602, or set the value to 0, make position deviation over-large detection invalid
The acceleration/ decelerate time Inner position command velocity is too small		Check the value of PA_312, PA_313 if it is too small or not	Enlarge the value of PA_312, PA_313. adjust gain of velocity control, improve trace performance.

Error code	Main	Extra	Display: "E28810"
	1A	0	Content: over-speed 1
Cause		confirmation	solution
Motor speed has exceeded the first speed limit (PA_321)		Check speed command if it is too large or not; check the voltage of analog speed command if it is too large or not; check the value of PA_321 if it is too small or not; check input frequency and division frequency coefficient of command pulse if it is proper or not; check encoder if the wiring is correct or not	Adjust the value of input speed command, enlarge the value PA_321 value, modify command pulse input frequency and division frequency coefficient, assure encoder wiring correctly

Error code	Main	Extra	Display: "E28200"
	21	0	Content: I/F input interface allocation error
Cause		confirmation	solution
The input signal are assigned with two or more functions.		Check the value of PA_400, PA_401, PA_402,PA_403,PA_404 if it is proper or not	Assure the value of PA_400, PA_401, PA_402, PA_403, PA_404 set correctly
The input signal aren't assigned with any functions.		Check the value of PA_400, PA_401,PA_402,PA_403,PA_404 if it is proper or not	Assure parameter PA_400, PA_401, PA_402,PA_403,PA_404 set correctly

Error code	Main	Extra	Display: "E28211"
	21	1	Content: I/F input interface function set error
Cause		confirmation	solution
Signal allocation error		Check the value of PA_400, PA_401, PA_402,PA_403,PA_404 if it is proper or not	Assure the value of PA_400, PA_401, PA_402, PA_403, PA_404 set correctly

Error code	Main	Extra	Display: "E28212"
	21	2	Content: I/F input interface function set error
Cause		confirmation	solution
The input signal are assigned		Check the value of PA_410,	Assure the value of PA_410,

with two or more functions.	PA_411, PA_412, PA_413, if it is proper or not	PA_411, PA_412, PA_413 set correctly
The input signal aren't assigned with any functions.	Check the value of PA_410, PA_411, PA_412, PA_413, if it is proper or not	Assure the value of PA_410, PA_411, PA_412, PA_413 set correctly

Error code	Main	Extra	Display: "E240"
	24	0	Content: CRC verification error when EEPROM parameter is saved
Cause		confirmation	solution
r,t terminal under-voltage		Check r,t terminal voltage	Assure r,t terminal voltage in proper range
Driver is damaged		save the parameters for several times	replace the driver with a new one

Error code	Main	Extra	Display: "E260"
	26	0	Content: positive negative over-travel input valid
Cause		confirmation	solution
positive /negative over-travelling input signal has been conducted		Check the state of positive negative over-travel input signal	/

Error code	Main	Extra	Display: "E570"
	57	0	Content: forced alarm input valid
Cause		confirmation	solution
Forced-alarm input signal has been conducted		Check forced-alarm input signal	Assure input signal wiring correctly

Chapter 6 Display and Operation

6.1 Introduction

The operation interface of servo driver consists of six LED nixie tubes and five key , which are used for servo driver's status display and parameter setting. The inter face layout is as follows :

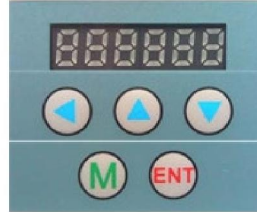

Figure 6-1 front panel

Table 6.1 The name and function of keys

Name	Key	Function
Display	/	There are 6 LED nixie tubes to display monitor value, parameter value and set value
Key of mode switch	M	Press this key to switch among 4 mode: 1.data monitor mode 2.parameter setting mode 3.auxiliary function mode 4.EEPROM written mode
Confirming key	ENT	Entrance for submenu, confirming input
Up key	▲	Press this key to increase the set value of current flash bit
Down key	▼	Press this key to decrease the set value of current flash bit
Left key	◀	Press this key to shift to the next digit on the left

6.2 Panel Display and Operation

6.2.1 Panel Operation Flow Figure

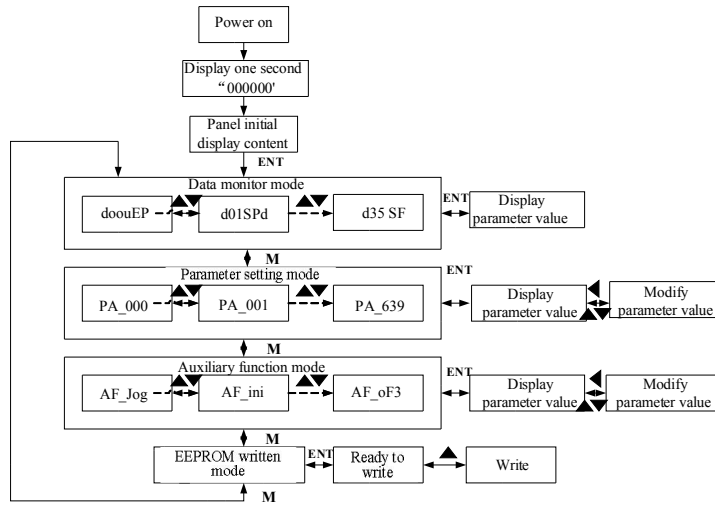





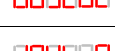







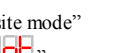
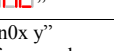







Figure 6-2 the flow diagram of panel operation

- (1) The front panel display  for about one second firstly after turning on the power of the driver. Then if no abnormal alarm occurs, monitor mode is displayed with the value of initial parameter ; otherwise, abnormal alarm code is displayed.
- (2) Press M key to switch the data monitor mode → parameter setting mode → auxiliary function mode → EEPROM written mode.
- (3) If new abnormal alarm occurs, the abnormal alarm will be displayed immediately in abnormal mode no matter what the current mode is, press M key to switch to the other mode.
- (4) In data monitor mode, press ▲ or ▼ to select the type of monitor parameter; Press ENT to enter the parameter type, then press ◀ to display the high 4 bits “H” or low 4 bits “L” of some parameter values.
- (5) In parameter setting mode, press ◀ to select current editing bit of parameter No, press ▲ or ▼ to change current editing bit of parameters No. Press ENT key to enter the parameter setting mode of corresponding parameters No. Press ◀ to select current bit of parameter value when editing it, press ▲ or ▼ to change the value of the bit. Press ENT to save it and switch to the interface of parameter No.

6.2.2 Driver Operating Data Monitor

Table 6.2 Function List of Driver Monitor

Serial Number	Name	Specification	Display	Unit	Data Format (x, y is numerical value)
---------------	------	---------------	---------	------	---------------------------------------

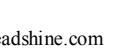
0	d00uEP	Positional command deviation		pulse	Low-bit "L xxxx" High-bit "H xxxx"
1	d01SPd	Motor speed		r/min	"r xxxx"
2	d02cSP	Positional command speed		r/min	"r xxxx"
3	d03cuL	Velocity control command		r/min	"r xxxx"
4	d04trq	Torque command		%	"r xxxx"
5	d05nPS	Feedback pulse sum		pulse	Low-bit "L xxxx" High-bit "H xxxx"
6	d06cPS	Command pulse sum		pulse	Low-bit "L xxxx" High-bit "H xxxx"
7	d07	/		/	" xxxx"
8	d08FPS	External scale feedback pulse sum		pulse	Low-bit "L xxxx" High-bit "H xxxx"
9	d09cnt	Control mode		/	Position: "  Speed: "  Torque: "  Composite mode" 
10	d10Io	I/O signal status		/	Input: "In0x y" (x:interface number, arbitrary value between1-8) (y:invalid -,valid A) output: "ot0x y" (x:interface series number, arbitrary value between1-8) (y:invalid -,valid A)
11	d11Ain	Analog input value		v	"x yyyy" x:A11 A,A12 b,A13 c
12	d12Err	Error factor and reference of history		/	"Er xxx"
13	d13 m	Alarm display		/	"m xxx"
14	d14 r9	Regeneration load factor		%	"rg xxx"
15	d15 oL	Over-load factor		%	"oL xxx"
16	d16Jrt	Inertia ratio		%	"J xxx"
17	d17 ch	Factor of no-motor running		/	"cP xxx"

















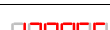

18	d18ict	No. of changes in I/O signals		/	“n xxx”
19	d19	/		/	“ xxx”
20	d20Abs	Absolute encoder data		pulse	Low-bit “L xxxx” High-bit”H xxxx”
21	d21AES	Absolute external scale position		pulse	Low-bit “L xxxx” High -bit”H xxxx”
22	d22rEc	No of Encoder/external scale communication errors monitor		times	“n xxx”
23	d23 id	Communication axis address		/	“id xxx” “Fr xxx”
24	d24PEP	Encoder positional deviation(encoder unit)		pulse	Low-bit “L xxxx” High -bit”H xxxx”
25	d25PFE	Encoder scale deviation (external scale unit)		pulse	Low-bit “L xxxx” High -bit”H xxxx”
26	d26hyb	hybrid deviation (command unit)		pulse	Low-bit “L xxxx” High -bit”H xxxx”
27	d27 Pn	Voltage across PN [V]		V	“u xxx”
28	d28 no	Software version		/	“d xxx” “F xxx” “P xxx”
29	d29ASE	Driver serial number		/	“n xxx”
30	d30NSE	Motor serial number		/	Low-bit “L xxxx” High -bit”H xxxx”
31	d31 tE	Accumulated operation time		/	Low-bit “L xxxx” High -bit”H xxxx”
32	d32Aud	Automatic motor identification		/	“r xxx”
33	d33Ath	Driver temperature		°C	“th xxx”
34	d34	/		/	“t xxx”
35	d35 SF	Safety condition monitor		/	“xxxxxx”

Table 6.3 “d17 ch” Motor No Rotate Reason Code Definition

Code	Display Code	Specification	Content
1		DC bus under-voltage	/

2	EE888E	No entry of Srv-On input	The Servo-ON input (SRV-ON) is not connected to COM-
3	EE8883	POT/NOT input is valid	PA_504=0,POT is open , speed command is positive direction NOT is open , speed command is negative direction
4	EE8884	Driver fault	/
6	EE8886	Pulse input prohibited (INH)	PA_518=0,INH is open
8	EE8888	CL is valid	PA_517=0,deviation counter clear is connected to COM-
9	EE8889	speed zero-clamp is valid	PA_315=1, speed zero-clamp is open

6.2.3 System Parameter Setting Interface

Table 6.4 Setup Interface of System Parameter

Class	No	Name	Display Code
0	01	control mode setup	EE0001
0	02	real-time auto-gain tuning	EE0002
0	03	selection of machine stiffness at real-time auto-gain tuning	EE0003
0	04	Inertia ratio	EE0004
0	06	command pulse rotational direction setup	EE0006
0	07	command pulse input mode setup	EE0007
0	09	1st numerator of electronic gear	EE0009
0	10	denominator of electronic gear	EE0010
0	11	output pulse counts per one motor revolution	EE0011
0	12	reversal of pulse output logic	EE0012
0	13	1st torque limit	EE0013
0	14	position deviation excess setup	EE0014
1	00	gain of 1st position loop	EE0000
1	01	gain of 1st velocity loop	EE0001
1	02	time constant of 1st velocity loop integration	EE0002
1	03	filter of 1st velocity detection	EE0003
1	04	time constant of 1st torque filter	EE0004
1	05	gain of 2nd position loop	EE0005

1	06	gain of 2nd velocity loop	PA0006
1	07	time constant of 2nd velocity loop integration	PA0007
1	08	filter of 2nd velocity detection	PA0008
1	09	time constant of 2nd torque filter	PA0009
1	10	Velocity feed forward gain	PA0010
1	11	Velocity feed forward filter	PA0011
1	12	Torque feed forward gain	PA0012
1	13	Torque feed forward filter	PA0013
1	14	2nd gain setup	PA0014
1	15	Control switching mode	PA0015
1	17	Control switching level	PA0017
1	18	Control switch hysteresis	PA0018
1	19	Gain switching time	PA0019
1	33	filter time constant of velocity command	PA0033
1	35	Positional command filter setup	PA0035
1	36	Encoder feedback pulse digital filter setup	PA0036
2	00	adaptive filter mode setup	PA0200
2	01	1st notch frequency	PA0201
2	02	1st notch width selection	PA0202
2	03	1st notch depth selection	PA0203
2	04	2nd notch frequency	PA0204
2	05	2nd notch width selection	PA0205
2	06	2nd notch depth selection	PA0206
2	22	Positional command smooth filter	PA0222
2	23	Positional command FIR filter	PA0223
3	00	Velocity setup internal/external switching	PA0300
3	01	Speed command rotational direction selection	PA0301
3	02	Speed command input gain	PA0302
3	03	Speed command reversal input	PA0303
3	04	1st speed setup	PA0304
3	05	2nd speed setup	PA0305
3	06	3rd speed setup	PA0306

3	07	4th speed setup	PA0307
3	08	5th speed setup	PA0308
3	09	6th speed setup	PA0309
3	10	7th speed setup	PA0310
3	11	8th speed setup	PA0311
3	12	Acceleration time setup	PA0312
3	13	Deceleration time setup	PA0313
3	14	Sigmoid acceleration/deceleration time setup	PA0314
3	15	Speed zero-clamp function selection	PA0315
3	16	Speed zero-clamp level	PA0316
3	17	torque setting switch	PA0317
3	18	Torque command direction selection	PA0318
3	19	Torque command input gain	PA0319
3	20	Torque command input reversal	PA0320
3	21	Speed limit value 1	PA0321
3	24	maximum speed of motor rotation	PA0324
4	00	SI 1 input selection	PA0400
4	01	SI 2 input selection	PA0401
4	02	SI 3 input selection	PA0402
4	03	SI 4 input selection	PA0403
4	04	SI 5 input selection	PA0404
4	10	SO 1 output selection	PA0410
4	11	SO 2 output selection	PA0411
4	12	SO 3 output selection	PA0412
4	13	SO 4 output selection	PA0413
4	22	Analog input 1(AI 1) offset setup	PA0422
4	23	Analog input 1(AI 1) filter	PA0423
4	28	Analog input 3(AI 3) offset setup	PA0428
4	29	Analog input 3(AI 3) filter	PA0429
4	31	Positioning complete range	PA0431
4	32	Positioning complete output setup	PA0432
4	33	INP hold time	PA0433

4	34	Zero-speed	PA:434
4	35	Speed coincidence range	PA:435
4	36	At-speed	PA:436
4	37	Mechanical brake action at stalling setup	PA:437
4	38	Mechanical brake action at running setup	PA:438
4	39	Brake action at running setup	PA:439
5	00	2nd numerator of electronic gear	PA:500
5	01	3rd numerator of electronic gear	PA:501
5	02	4th numerator of electronic gear	PA:502
5	03	Denominator of pulse output division	PA:503
5	06	Sequence at servo-off	PA:506
5	08	Main power off LV trip selection	PA:508
5	09	Main power off detection time	PA:509
5	13	Over-speed level setup	PA:513
5	15	I/F reading filter	PA:515
5	28	LED initial status	PA:528
5	29	RS232 baud rate setup	PA:529
5	30	RS485 baud rate setup	PA:530
5	31	Axis address	PA:531
6	03	JOG trial run command torque	PA:603
6	04	JOG trial run command speed	PA:604
6	08	Positive direction torque compensation value	PA:608
6	09	Negative direction torque compensation value	PA:609
6	20	distance of trial running	PA:620
6	21	waiting time of trial running	PA:621
6	22	cycling times of trial running	PA:622

6.2.4 Auxiliary Function

Table 6.5 setting interface System parameter

No	Name	Specification	Display Code	Operation Flow
0	AF_jog	Trial run	PA:0009	Please refer to the chapter of "trial run"
1	AF_InI	Initialization of parameter	PA:0000	1. press ENT to enter operation, display "PA:0000". 2. press ▲ once to display "PA:0000",

				indicated initialization; after finishing it, display "E000SH".
2	AF_unL	Release of front panel lock	E00000	<ol style="list-style-type: none"> 1. press ENT to enter operation, display "L00000". 2. press ▲ button one time, display "E000SH", indicated unlock the panel successfully
3	AF_AcL	Alarm clear	E00000	<ol style="list-style-type: none"> 1. press ENT to enter operation, display "A00000". 2. press ▲ once, display "E000SH", indicated alarm clear successfully
4	AF_oF1	A1 automatic offset adjustment	E00000	<ol style="list-style-type: none"> 1. press ENT to enter operation, display "000000". 2. press ▲ once, display "S00000", indication start correct, then display "E000SH" indicated correction finished.
5	AF_oF2	A2 automatic offset adjustment	E00000	<ol style="list-style-type: none"> 1. press ENT to enter operation, display "000000". 2. press ▲ once, display "S00000", indicated start to correct the offset, then display "E000SH" indicated that correction finished.
6	AF_oF3	A3 automatic offset adjustment	E00000	<ol style="list-style-type: none"> 1. press ENT to enter operation, display "000000". 2. press ▲ once, display "S00000", indicated start to correct the offset, then display "E000SH" indicated correction finished.

Table 6.6 The Locked panel conditions

Mode	The Locked panel conditions
Monitor mode	No limitation: all monitored data can be checked.
Parameter set up mode	No parameter can be changed but setting can be checked.
Auxiliary function mode	Cannot be run except for "release of front panel lock"
EEPROM writing mode	No limitation

6.2.5 Saving parameter

Operation procedure:

1. press M to select EEPROM writing mode, display "E00000";
2. Press ENT to enter into writing mode operation:

3. Press and hold ▲, display LED from "EEF000" to "EEF001", then it become "EEF002", finally it become "EEF003", indicated EEPROM writing operation have been began;
4. "EEF004" means that writing is unsuccessful while "EEF005" show that the writing is successful; Follow steps 3 and 4 to repeat the operation; the drive may be damaged if repeat of several times still fails. The driver need to repair.
5. The driver need to power off and restart again if writing is successful .

NOTE: Don't turn off the power if EEPROM writing operation goes on, otherwise it may cause a writing wrong data; If this happens, please reset all the parameters ,then do EEPROM writing operation again.

6.2.6 Abnormal Alarm

The front panel will automatically enter the abnormal alarm display mode if driver error occurs while it displays the corresponding error code. Please refer to Chapter 5 of alarm processing about the detail of error code.

Chapter 7 Trial Run

Attention

- Ground the earth terminal of the motor and driver without fail. the PE terminal of driver must be reliably connected with the grounding terminal of equipment.
- The driver power need with isolation transformer and power filter in order to guarantee the security and anti-jamming capability.
- Check the wiring to make sure correctness before power on.
- Install a emergency stop protection circuit externally, the protection can stop running immediately to prevent accident happened and the power can be cut off immediately.
- If drive alarm occurs, the cause of alarm should be excluded and Svon signal must be invalid before restarting the driver.
- The high voltage also will contain in several minutes even if the servo driver is powered off, please don't touch terminal strip or separate the wiring.
-

Note: there are two kinds of trial run : trial run without load and trial run with load . The user need to test the driver without load for safety first.

7.1 Inspection Before trial Run

7.1.1 Inspection on wiring

Table 7.1 inspection Item Before Run

No	Item	Content
1	Inspection on wiring	1. Ensure the following terminals are properly wired and securely connected : the input power terminals, motor output power terminal ,encoder input terminal CN2, control signal terminal CN1, communication terminal CN4(it is unnecessary to connect CN1 andCN4 in Jog run mode) 2.short among power input lines and motor output lines are forbidden , and no short connected with PG ground.
2	Confirmation of power supply	1. The range of control power input r, t must be in the rated range. 2. The range of the main power input R, S, T must be in the rated range.
3	Fixing of position	the motor and driver must be firmly fixed
4	Inspection without load	the motor shaft must not be with a mechanical load.
5	Inspection on control signal	1, all of the control switch must be placed in OFF state. 2, servo enable input Srv_on must be in OFF state.

7.1.2 Timing chart on power-up

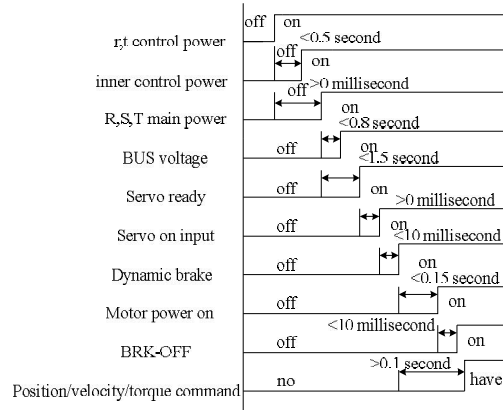

7.1.3 Timing chart on fault

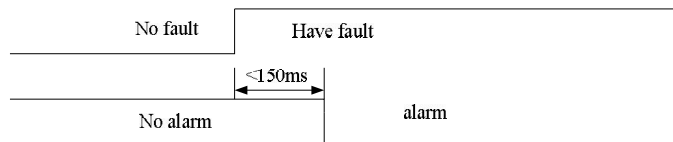

7.1.4 holding brake

In applications where the motor drives the vertical axis, this brake would be used to hold and prevent the work (moving load) from falling gravity while the power to the servo is shut off .

**Never use this for “Brake” purpose to stop the load in motion.
Use this built-in brake for “holding” purpose only. That is to hold the stalling status.**

For the brake release timing at power-on ,or braking timing at servo-off/servo-alarm while the motor is in motion ,refer to chapter 7.1.2 timing chart on power-up.
You can follow the diagram about the wiring below :

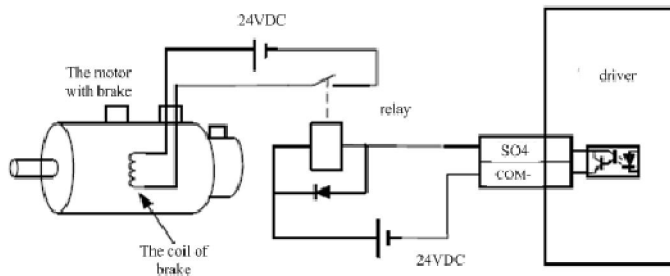

About the wire of brake ,there should be an 24VDC for brake, the brake will be loosed with the 24VDC input, and the driver give an output signal to control the connection or disconnection of the 24VDC , pin 31 and pin 35 of CN1 is the control signal , and it is forbidden to connect these signal directly for the power of 24VDC , it will destroy the hardware of servo driver.

And if you connect the pin31 and pin35 for controlling the brake , just make sure the setting value of Pr4.13. The default is 00000303h , if the driver works in torque mode , this value should be changed to 00030303h .

7.2 Trial Run

After installation and connection is completed , check the following items before turning on the power:

- Wiring ? (especially power input and motor output)
- Short or grounded ?
- Loose connection ?
- Unstable mounting ?
- Separation from the mechanical system ?

7.2.1 Jog Control

It is unnecessary to connect control signal terminal CN1 and communication terminal CN4 in Jog run mode. It is recommended that motor runs at low speed for safety, while the speed depends on the parameters below: there are two different modes : **speed JOG mode** and **location JOG mode**.

Table 7.2 Parameter Setup of Velocity JOG







No	parameter	name	Set value	unit
1	PA_001	Control mode setting	1	/
2	PA_312	Acceleration time setup	User-specified	millisecond
3	PA_313	Deceleration time setup	User-specified	millisecond
4	PA_314	Sigmoid acceleration/deceleration time setup	User-specified	millisecond
5	PA_604	JOG trial run command speed	User-specified	rpm

Table 7.3 Parameter Setup of Position JOG

No	parameter	name	value	unit
1	PA_001	Control mode setting	0	/
2	PA_312	Acceleration time setup	User-specified	millisecond
3	PA_313	Deceleration time setup	User-specified	millisecond
4	PA_314	Sigmoid acceleration/deceleration time setup	0	millisecond
5	PA_604	JOG trial run command speed	User-specified	rpm
6	PA_620	distance of trial running	User-specified	0.1 rotation
7	PA_621	waiting time of trial running	User-specified	millisecond
8	PA_622	cycling times of trial running	User-specified	times

◆JOG trial run operation process

1. set all parameters above corresponding to velocity JOG or position JOG ;
2. Enter EEPROM writing mode, and save the value of modified parameters ;
3. The driver need to restart after the value is written successfully;
4. Enter auxiliary function mode, and go to “**PA604**” sub-menu;

5. Press ENT once, and display "000000";
6. Press  once, and display "500000" if no exception occurs; press  once again if "E00000" occurs, it should display "500000"; If "E00000" still occurs, please switch to data monitoring mode "000000" sub-menu, find the cause why motor doesn't rotate, fix the trouble and try again;
7. In position JOG mode, the motor will rotate directly; if motor doesn't rotate, switch to data monitoring mode "000000" sub-menu, find the cause why motor doesn't rotate, fix the trouble and try again; In speed JOG mode, press  once, the motor rotates once (hold  will make motor rotating to value of PA_604), and display "000000"; press  once, the motor rotates once (hold  will make motor rotating to value of PA_604), and display "000000"; if motor doesn't rotate, switch to data monitoring mode "000000" sub-menu, find the cause why motor doesn't rotate, fix the trouble and try again;
8. Press ENT will exit JOG control in JOG run mode.

7.2.2 Position Control

Notice : You must do inspection before position control test run.

Table 7.4 Parameter Setup of Position Control

No	parameter	name	input	value	unit
1	PA_001	control mode setup	/	0	/
2	PA_312	Acceleration time setup	/	User-specified	millisecond
3	PA_313	Deceleration time setup	/	User-specified	millisecond
4	PA_314	Sigmoid acceleration/deceleration time setup	/	User-specified	millisecond
5	PA_005	Command pulse input select	/	0	/
6	PA_007	Command pulse mode select	/	3	/
7	PA_518	Command pulse prohibit input invalidation	/	1	/
8	PA_400	SI1 input select	Srv_on	Hex:0003	/

◆ Wiring Diagram

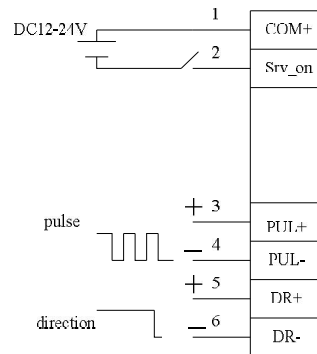

Figure 7-3 Control Terminal CN1 Signal Wiring in Position Control Mode

◆Operation Steps

1. connect terminal CN1.
2. Enter the power (DC12V to 24V) to control signal (the COM + and COM-).
3. Enter the power to the driver.
4. Confirm the value of the parameters, and write to the EEPROM and turn off/on the power (of the driver)
5. Connect the Srv_on input to bring the driver to servo-on status and energize the motor.
6. Enter low-frequency pulse and direction signal to run the motor at low speed.
7. Check the motor rotational speed at monitor mode whether, ("881588"),
 Rotational speed is as per the setup or not, and
 The motor stops by stopping the command (pulse) or not
 If the motor does not run correctly, refer to the Factor of No-Motor running in data monitor mode
 ("888888").

7.2.3 Velocity Control

Notice : You must do inspection before velocity control test run.

Table 7.5 Parameter Setup of Velocity Control

No	Parameter	Name	input	Setup value	Unit
1	PA_001	Control mode setup	/	1	/
2	PA_312	Acceleration time setup	/	User-specified	millisecond
3	PA_313	Deceleration time setup	/	User-specified	millisecond
4	PA_314	Sigmoid acceleration/deceleration time setup	/	User-specified	millisecond
5	PA_315	Zero speed clamping function select	/	1	/
6	PA_300	Velocity setup internal and external switching	/	User-specified	/
7	PA_301	Speed Command direction selection	/	User-specified	/
8	PA_302	Speed command input gain	/	User-specified	Rpm/V
9	PA_303	Speed setting input reversal	/	User-specified	/
10	PA_422	Analog input I(AI1) offset setup	/	User-specified	0.359mv
11	PA_423	Analog input I(AI1) filter	/	User-specified	0.01ms
12	PA_400	SI1 input selection	Srv_on	hex:0300	/
13	PA_401	SI2 input selection	ZeroSpd	hex:1100	/
14	PA_402	SI3 input selection	IntSpd1	hex:0E00	/
15	PA_403	SI4 input selection	IntSpd2	hex:0F00	/
16	PA_404	SI5 input selection	IntSpd3	hex:1000	/
17	PA_405	SI6 input selection	Vc-Sign	hex:1200	/

◆Wiring Diagram

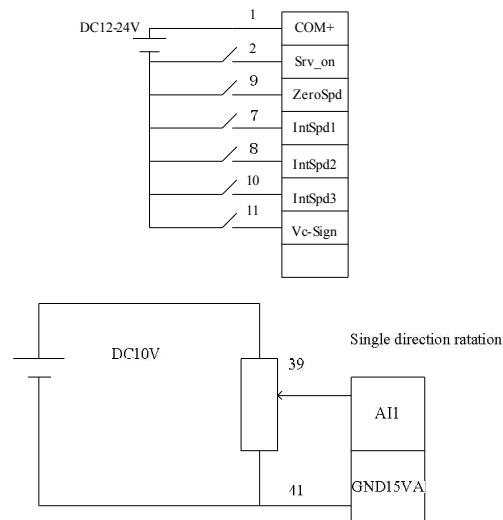

◆ Operation steps

1. connect terminal CN1.
2. Enter the power (DC12V to 24V) to control signal (the COM + and COM-).
3. Enter the power to the driver.
4. Confirm the value of the parameters, and write to the EEPROM and turn off/on the power (of the driver)
5. Connect the Srv_on input to bring the driver to servo-on status and energize the motor.
6. apply DC voltage between velocity command input ,A11 and AGND, and gradually increase from 0V to confirm the motor runs.
7. Check the motor rotational speed at monitor mode , (" **000000** ")
 - Whether rotational speed is as per the setup or not, and
 - Whether the motor stops with zero command or not
 - If the motor does rotate at a micro speed with command voltage of 0.
8. When you want to change the rotational speed and direction, set up the following parameters again.
Pr3.00. Pr3.01. Pr3.03
If the motor does not run correctly, refer to the Factor of No-Motor running in data monitor mode (" **000000** ").

7.2.4 Torque Control

Notice : You must do inspection before torque control test run.

Table 7.6 Parameter Setup of Torque Control

No	Parameter	Name	input	Setup value	Unit
----	-----------	------	-------	-------------	------

1	PA_001	Control mode setup	/	2	/
2	PA_312	Acceleration time setup	/	User-specified	millisecond
3	PA_313	Deceleration time setup	/	User-specified	millisecond
4	PA_314	Sigmoid acceleration/deceleration time setup	/	User-specified	millisecond
5	PA_315	Zero-clamp function selection	/	0	/
6	PA_317	Torque setup internal/external switching	/	0	/
7	PA_319	Torque command direction input gain	/	User-specified	0.1V/100%
8	PA_320	Torque setup input reversal	/	User-specified	/
9	PA_321	Speed limit value 1	/	User-specified	R/min
10	PA_400	SI1 input selection	Srv_on	hex:030000	/
11	PA_428	Analog input 3(AI3) offset setup	/	User-specified	0.359mv
12	PA_429	Analog input 3(AI3) filter	/	User-specified	0.01 ms

◆Wiring Diagram

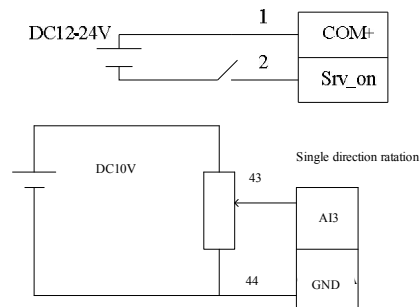

◆Operation Steps

1. connect terminal CN1.
 2. Enter the power (DC12V to 24V) to control signal (the COM + and COM-).
 3. Enter the power to the driver.
 4. Confirm the value of the parameters, and write to the EEPROM and turn off/on the power (of the driver)
 5. Connect the Srv_on input to bring the driver to servo-on status and energize the motor.
 6. apply DC voltage between torque command input ,AI1 and AGND, and gradually increase from 0V to confirm the motor runs.
 7. Check the motor torque at monitor mode ("004888"), Whether actual torque is as per the setup or not
 8. When you want to change the torque magnitude, direction and velocity limit value against the command voltage, set up the following parameters : Pr3.19. Pr3.20. Pr3.21
- If the motor does not run correctly, refer to the Factor of No-Motor running in data monitor mode ("888888").

7.3 Automatic Control Mode Run

7.3.1 Operation Mode Selection

EL5 series AC servo drives support the position, speed, torque three basic modes of operation, and can switch freely between the three basic modes of operation by switch or modify parameters.

Table 7.7 Parameter setup of Operation Mode Selection

No	Mode	Parameter	Specification
1	Position mode	PA_001=0	The position control is performed based on the positional command (pulse train) from the host controller or the command set in the servo driver.
2	Velocity mode	PA_001=1	The velocity control is performed according to the analog speed command from the host controller or the speed command set in the servo driver.
3	Torque mode	PA_001=2	The torque control is performed according to the torque command specified in the form of analog voltage or the command set in the servo driver.
4	1st mode: position mode 2nd mode: speed mode	PA_001=3	The control mode is switched through external input.
5	1st mode: position mode 2nd Mode: torque mode	PA_001=4	The control mode is switched through external input.
6	1st mode: speed mode 2nd Mode: torque mode	PA_001=5	The control mode is switched through external input.

The step of changing the operation mode:

- 1, Switch the driver to Servo Off status.
 - 2, Modify the corresponding parameters of control mode to EEPROM.
- Turn off/on the power to make the new mode works after setup completed.

7.3.2 Position Mode

The driver is widely used for precise positioning in position control mode.

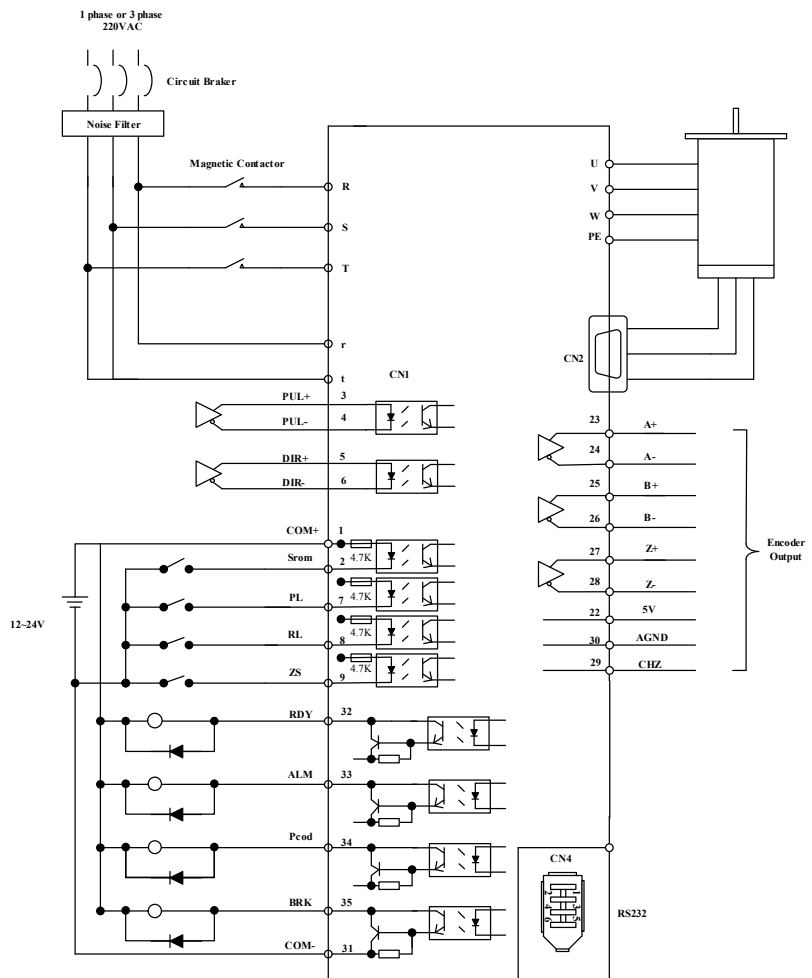

Figure 7-6 Position Mode Typical Wiring Diagram

Corresponding parameters setup of position control mode

1. Process of command pulse input

The positional commands of the following 3 types (pulse train) are available.

- ◆A, B phase pulse
- ◆Positive direction pulse/negative direction pulse
- ◆Pulse train + sign

Please set the pulse configuration and pulse counting method based on the specification and configuration of installation of the host controller.

Table 7.8 Parameter Setup of Position Command Selection

No	Parameter	Name	Setup method
1	PA_006	Command pulse polar setting	Please refer to chapter 4
2	PA_007	Command pulse input mode setting	

2. Electronic gear function

The function multiplies the input pulse command from the host controller by the predetermined dividing or multiplying factor and applies the result to the position control section as the positional command. By using this function, desired motor rotations or movement distance per unit input command pulse can be set.

Table 7.9 Parameter Setup of Electronic Gear Ratio

No	Parameter	Name	Setup method
1	PA_009	First command frequency double molecular	Please refer to chapter 4
2	PA_010	Command frequency double denominator	
3	PA_500	The second command divide double frequency molecular	
4	PA_501	The third command divide double frequency molecular	
5	PA_502	The fourth command divide double frequency molecular	

3. Position command filter

To make the positional command divided or multiplied by the electronic gear smooth, set the command filter.

Table 7.10 Parameter Setup of Position Command Filter

No	Parameter	Name	Setup method
1	PA_222	Positional command smoothing filter	Please refer to chapter 4
2	PA_223	Positional command FIR filter	

4. Motor encoder pulse output

The information on the amount of movement can be sent to the host controller in the form of A and B phase pulses from the servo driver.

Table 7.11 Parameter Setup of Driver Encoder Pulse Output

No	Parameter	Name	Setup method
1	PA_011	Encoder pulse output molecular	Please refer to chapter 4
2	PA_012	Pulse output logic reverse	
3	PA_503	Pulse output divide frequency denominator	
4	PA_533	Pulse regeneration output boundary set	

5. Deviation Counter clear

The deviation counter clear input (CL) clears the counts of positional deviation counter at the position control to 0.

Table 7.12 Parameter Setup of Deviation Counter Clear

No	parameter	name	Setup method
1	PA_517	Counter clear input mode	Please refer to chapter 4

6. Position complete output (INP)

The completion of positioning can be verified by the positioning complete output (INP). When the absolute value of the positional deviation counter at the position control is equal to or below the positioning complete Range by the parameter, the output is ON. Presence and absence of positional command can be specified as one of judgment conditions.

Table 7.13 Related Parameter Setup of Position Complete Output

No	Parameter	Name	Setup method
1	PA_431	Position complete range	Please refer to chapter 4
2	PA_432	Position complete output setup	
3	PA_433	INP hold time	

And the output port should be assigned for “INP”, for details of these parameters, refer to PA_410 – PA415.

7. Command pulse prohibit (INH)

The command pulse input counting process can be forcibly terminated by using the command pulse inhibit input signal (INH). When INH input is ON, the servo driver ignores the command pulse, disabling pulse counting function.

Table 7.14 Related Parameter Setup of Command Pulse Prohibit

No	Parameter	Name	Setup method
1	PA_518	Command pulse prohibit input invalid setup	Please refer to chapter 4
2	PA_519	Command pulse prohibit input read setup	

And the input port should be assigned for “INH”, for details of these parameters, refer to PA_400 – PA409.

8. Other setup for SI/SO function

For details of SI input function, refer to PA_400 – PA409.

For details of SO output function, refer to PA_410 – PA415.

7.3.3 Velocity Mode

The driver is widely used for accuracy speed control in velocity control mode.

You can control the speed according to the analog speed command from the host controller or the speed command set in servo driver.

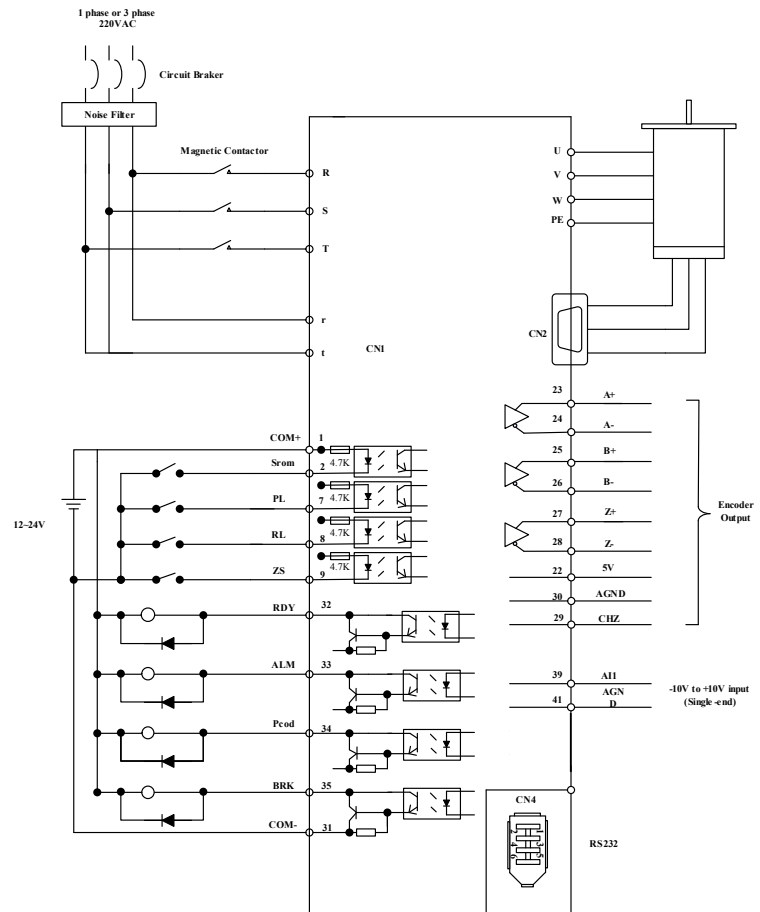

Figure 7-7 Velocity Mode Typical Wiring Diagram

Relevant parameters setup of velocity control mode

1. Velocity control by analog speed command

The analog speed command input voltage is converted to equivalent digital speed command. You can set the filter to eliminate noise or adjust the offset.

Table 7.15 Parameter Setup of Analog Speed Command

No	Parameter	Name	Setup method
1	PA_300	Velocity setup internal/external switching	Please refer to chapter 4
2	PA_301	Speed command rotational direction selection	
3	PA_302	Speed command input gain	
4	PA_303	Speed command reversal input	
5	PA_422	Analog input 1(AI 1) offset setup	

6	PA_423	Analog input 1(AI 1) filter	
---	--------	-----------------------------	--

2. Velocity control by internal speed command

You can control the speed by using the internal speed command set to the parameter. By using the internal speed command selection 1,2,3(INTSPD 1,2,3), you can select best appropriate one

Table 7.16 Parameter Setup of Internal Speed Commands Carry Out Speed Control

No	parameter	name	Setup method
1	PA_300	Velocity setup internal/external switching	Please refer to chapter 4
2	PA_301	Speed command rotational direction selection	
3	PA_304	1st speed setup	
4	PA_305	2nd speed setup	
5	PA_306	3rd speed setup	
6	PA_307	4th speed setup	
7	PA_308	5th speed setup	
8	PA_309	6th speed setup	
9	PA_310	7th speed setup	
10	PA_311	8th speed setup	

3. Speed zero clamp (ZEROSPD)

You can forcibly set the speed command to 0 by using the speed zero clamp input.

Table 7.17 Parameter setup of speed zero clamp

No	parameter	name	Setup method
1	PA_315	Speed zero-clamp function selection	Please refer to chapter 4
2	PA_316	Speed zero clamp level	

And the input port should be assigned for “ZEROSPD”, for details of these parameters, refer to PA_400 – PA409.

4. Attained speed output (AT-SPEED)

The signal AT-SPEED is output as the motor reaches the speed set to Pr4.36”attained speed”

Table 7.18 Parameter Setup of attained speed output

No	Parameter	Name	Setup method
1	PA_436	At-speed	Please refer to chapter 4

And the output port should be assigned for “AT-SPEED”, for details of these parameters, refer to PA_410 – PA415.

5. Speed coincidence output (V-COIN)

The signal is output when the motor speed is equal to the speed specified by the speed command. The motor speed is judged to be coincident with the specified speed when the difference from the speed command before/after acceleration/deceleration is within the range specified by Pr4.35”Speed coincident range”

Table 7.19 Parameter Setup of Speed Coincidence Output

No	Parameter	Name	Setup method
1	PA_435	Speed coincidence range	Please refer to chapter 4

And the output port should be assigned for “V-COIN”, for details of these parameters, refer to PA_410 – PA415.

6. Speed command accelerates and decelerates setup

This function controls the speed by adding acceleration or deceleration instruction in the driver to the input speed command.

Using this function, you can use the soft start when inputting stepwise speed command or when using internal speed setup. You can also use S shaped acceleration/deceleration function to minimize shock due to change in speed.

Table 7.20 Parameter Setup of Speed Command Acceleration/Deceleration

No	Parameter	Name	Set method
1	PA_312	Acceleration time setup	Please refer to chapter 4
2	PA_313	Deceleration time setup	
3	PA_314	Sigmoid acceleration/deceleration time setup	

When the position loop is external to the driver, don't use the acceleration/deceleration time setting. Set these values to 0.

7. SISO function setup.

For details of SI input function, refer to PA_400 – PA409.

For details of SO output function, refer to PA_410 – PA415.

7.3.4 Torque Mode

The torque control is performed according to the torque command specified in the form of analog voltage. For controlling the torque, the speed limit input is required in addition to the torque command to maintain the motor speed within the speed limit.

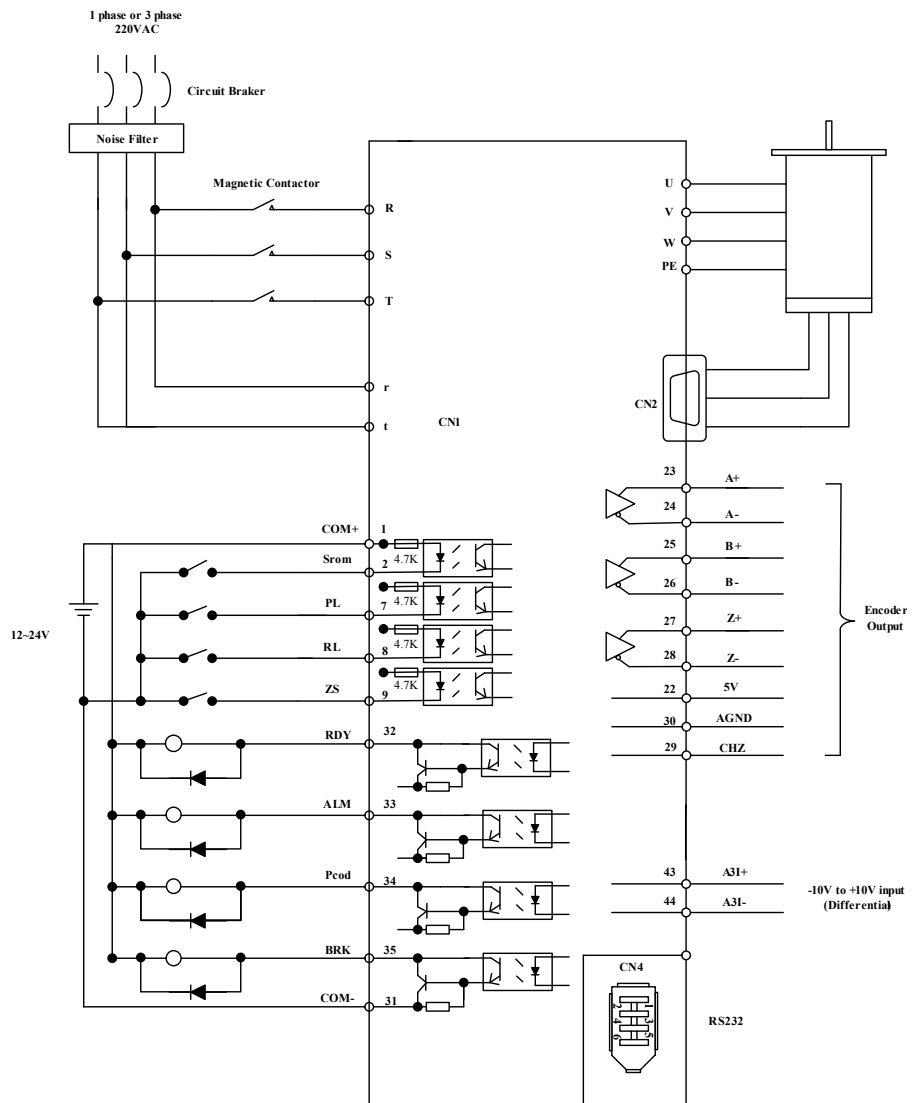

Figure 7-8 Torque Mode Typical External Wiring Diagram

Relevant parameters setup of torque control mode

1. Analog torque command input

Table 7.21 Parameter Setup of Analog Torque Command Input

No	Parameter	Name	Setup Method
1	PA 318	Torque command direction selection	Please refer to chapter 4

2	PA_319	Torque command input gain	
3	PA_320	Torque command input reversal	
4	PA_422	Analog input 1(AI 1) offset setup	
5	PA_423	Analog input 1(AI 1) filter	
6	PA_428	Analog input 3(AI 3) offset setup	
7	PA_429	Analog input 3(AI 3) filter	

2. Speed limit function

The speed limit is one of protective functions used during torque control. This function regulates the motor speed so that it doesn't exceed the speed limit while the torque is controlled.

Table 7.22 Parameter Setup of Speed Limit Function

No	Parameter	Name	Setup method
1	PA_321	Speed limit value 1	Please refer to chapter 4
2	PA_315	Zero-clamp function selection	
3	PA_302	Speed command input gain	
4	PA_422	Analog input 1(AI 1) offset setup	
5	PA_423	Analog input 1(AI 1) filter	

3. S/ISO function set

For details of SI input function, refer to PA_400 – PA409.
 For details of SO output function, refer to PA_410 – PA415.

Chapter 8 Product Specification

Notice

Servo driver must be matched with relevant servo motor, this manual describes shenzhen Leadshine EL5 series servo motor.

8.1 Driver Technical Specification

Table 8.1 Driver Specification

Parameter	EL5-D-0400	EL5-D-0750	EL5-D-1000	EL5-D-1500
Rated output power	400W	750W	1KW	1.5KW
Rated output current	2	3.7	5	7.5
Max output current	8.5	16	22	25
Main power	Single phase or three phase 220V -15%~+10% 50/60HZ			
Control power	Single phase 220V -15%~+10%			
Control mode	IGBT SVPWM sinusoidal wave control			
Feedback mode	2500P/R incremental encoder/17-bit encoder			
Input pulse	0-500kHz,5V differential input			
Adjust speed ratio	3000:1			
Position bandwidth	200HZ			
Electronic gear ratio	1~32767/1~32767			
Analog input	-10~10Vdc,input resistance 20KΩ, no isolation			
Velocity bandwidth	500HZ			
Input signal	Servo enable, over-travel inhibition, gain switching, command pulse inhibition, speed zero clamp, deviation counter clear, alarm clear			
Output signal	Alarm output, servo-ready, at-speed, zero-detection, velocity coincidence			
Encoder signal output	A phase, B phase, Z phase, long-distance drive mode output			
Alarm function	Over-voltage, under-voltage, over-current, over-load, encoder error, position deviation error, brake alarm, limit alarm, over-speed error etc.			
Operation and display	jog, trapezoidal wave test, each parameter and input output signal can be modified and saved, six-bit LED to display rotational speed, current, position deviation, driver type version and address ID value etc.			
Debug software	You can adjust the parameters of current loop, velocity loop, position loop, and change the value of input and output signals and the parameter of motor and save the values to the files which can be downloaded and uploaded, monitor the waveform of velocity and position in the ladder.			
Communication interface	RS-232,RS485			
Brake mode	Built-in brake 50Ω/50W			
Adapt load inertia	Less than 5 times motor inertia			
weight	About 1.5-2.5Kg			
environment	Environment	Avoid dust, oil fog and corrosive gases		
	Ambient Temp	0 to +40℃		
	Humidity	40% RH to 90%RH, no condensation		
	Vibration	5.9 m/s ² MAX		
	Storage Temperature	-20~80℃		
Installation	Vertical installation			

8.2 Accessory selection

1. motor cable
2. encoder cable
3. protuner cable
4. control signal terminal CN1 (44 pin)
5. control signal shell CN1

Chapter 9 Order Guidance

9.1 Capacity Selection

To determine the capacity of servo system, we must consider the inertia of load, torque of load, the positioning accuracy, the requirement of the highest speed, consider the selection according to the following steps:

1) Calculate Inertia of Load and Torque

You can refer to relative information to calculate inertia of load, torque of load, acceleration/deceleration torque as the next step basis.

2) Identify Mechanical Gear Ratio

According to the maximum speed and the highest speed of the motor ,you can calculate the maximum of mechanical reduction ratio, by using it and minimum of motor turning unit ,to calculate if they can meet the requirements of the smallest position unit or not. If the positional precision is high, you can increase the mechanical reduction ratio or select motor with higher capacity.

3) Calculate Inertia and Torque.

Convert mechanical reduction ratio of the load inertia and load torque to the motor shaft, while the result shall be not 5 times more than motor inertia. If the requirements can't be matched, you can increase the mechanical reduction ratio (the actual maximum speed reducing) or select larger capacity motor.

9.2 Electronic Gear Ratio

In position control mode, the actual speed = command pulse velocity× G ×mechanical reduction ratio.
In position control mode, the actual load minimum displacement = minimum command pulse travel ×G ×mechanical reduction ratio.

【Note】 If the electronic gear ratio of G is not 1, gear ratio division may have the remainder, then there will be position deviation existed, the maximum deviation is the minimum of rotation (minimum resolution).

Appendix

How to debug the parameter of driver matched with different servo motor

Sometimes, we use different motor with EL5 servo motor. Then we need to set the different value of motor parameter for different motor.

So, we give you some examples for debugging the parameter.

A. Set the 400w servo motor for 400w servo driver.

If the 400w white motor is like this (the motor is with 10 poles):



Here is the step to modify the values of parameters for matching this white motor with driver:

1. Modify the value of pr7.15 to f.

The 400W servo motor is included in the motor library, so you just need to modify the parameter of pr7.15, modify pr7.15 to make pr7.15 =f, while the driver should be powered on and connected to the software Protuner when you modify the value of parameter.

2. Download the new value of parameters to the driver and save it, and restart the driver to make the new value worked.

NOTICE: If the 400w motor isn't the white motor which looks like the picture above, just contact the provider of motor to get the information of motor specification.

B. Set the motor which is not included in motor library.

1. Modify the value of pr7.15 to 0.

Sometimes servo motor isn't included in motor library, so you need to modify the parameter of pr7.15 to 0, and then you can set other parameters to match the motor with driver.

2. Modify the values of other parameters : pr7.00 – pr7.14

In general, the parameters pr7.00- pr7.14 are hidden, you can't see them. You need to do some operation to find them, refer to the appendix on how to find the hidden parameters. And then, modify the parameters after you find all the parameters. The driver should be powered on and connected to the software Protuner when you modify them.

You need to refer to the specification of motor, get the information below:

motor pole pairs, motor phase resistor, motor D/Q inductance, motor back EMF coefficient, motor torque coefficient, motor rated speed, motor maximum speed, motor rated current, motor rotor inertia, motor power selection.

Then, set the value of motor specification to pr7.02 – pr7.14

3. Download the new value of parameters

Download the new values to the driver and save it, and restart the driver to make the new value worked.

NOTICE: Contact the provider of motor for specification of motor.

Contact us

China Headquarters

Address: 3/F, Block 2, Nanyou Tianan Industrial Park, Nanshan District Shenzhen, China

Website: <http://www.leadshine.com>

Sales Hot Line:

Tel: 86-755-2641-7674 (for Asia, Australia, Africa areas)

86-755-2640-9254 (for Europe areas)

86-755-2641-7617 (for Europe areas)

Fax: 86-755-2640-2718

Email: sales@leadshine.com.

Technical Support:

Tel: 86-755-2641-8447, 86-755-2641-8774, 86-755-2641-0546

Fax: 86-755-2640-2718

Email: tech@leadshine.com(for All)

Leadshine U.S.A

Address: 25 Mauchly, Suite 318 Irvine, California 92618

Tel: 1-949-608-7270

Fax: 1-949-608-7298

Web: <http://www.leadshineUSA.com>

Email: sales@leadshineUSA.com and support@leadshineUSA.com.